

Casino Chip And Token News

A Quarterly Magazine for Members of
the Casino Chip and Gaming Token Collectors Club



Summer Issue:

July, August, September, 2000

Volume 13, #3

A Member of the
American Numismatic
Association
(C-140538)

IN THIS ISSUE:

**COVER STORY: BOURGONGNE ET GRASSET,
ANTIQUE COLLECTIBLES, PRESIDENT'S LETTER
AND MUCH MORE!!!**



Standard Plaques & Jetons

Illustrated below are our simplest form of jetons and plaques. These are available in a huge variety of colours as are all our jetons and plaques. The jetons and plaques shown are convenient for use with small values.

The standard finish is mother of pearl. Our expertise in printing allows you to customize both sides of the jeton or plaque. An example would be the name of the casino including the value and an image such as a building, landscape or logo. The printing is embedded in the plaque or jeton and therefore is immune to wear or scratching.

The two most common printed colours are black and gold. Other colours are available on request.



Backgrounds & Finishes

It is the choice of colours and finishes which make our jetons and plaques so unique.

We offer jetons and plaques made with one colour or with two or three different colours. This can be combined with various types of finishes:

- * Mother of pearl
- * White lace which can be overlaid on the mother of pearl
- * Gold lace which enhances both the aesthetic and security aspects of the jetons and plaques.
- * Lamé which offers the brightest finish

The above options may be combined with our 28 colours in combinations of two or three colours. This gives you the possibility of 222 combinations of finishes.

Please note: due to the restrictions of photography and printing the samples shown below in no way represent the fine finish which we achieve on our jetons and plaques.



Base colour



Mother of pearl on base colour



mother of pearl



white lace on top of base colour



gold lace on top of base colour on mother of pearl



gold lace on top of mother of pearl on base colour



gold lamé on top of base colour



white lace underneath base colour



Plaques & Jetons two stripes or three stripes

Illustrated here are two and three stripe plaques. You may choose from 28 colours. The colours can run vertically or horizontally. This applies to round, square, oblong and oval jetons and plaques.



Two stripe oval plaque



Three stripe plaque, vertical



Three stripe plaque, horizontal

Plaques & Jetons with lunettes

Having selected the type of finish, the combination of colours and printing that you require you may now wish to add lunettes to your jeton or plaque. These lunettes are manufactured from a contrasting material and are inserted into the jeton or plaque. Normally they are made from a see through material and are decorated to increase both the security aspect and visual appeal. One, two or three lunettes can be inserted in the plaque and can be placed independently. A lunette can be blank or printed. Usually the style and colour of the lunette is selected by our designer, but if you wish you may select the finish yourself.



Plaques & Jetons with lunettes

To further improve the security and visual appeal of our jetons and plaques we offer the option of using overlapping lunettes. The lunettes can be made from a combination of materials and as before can be printed or plain.



We can produce lunettes in various shapes as illustrated to even further enhance your plaques or jetons.

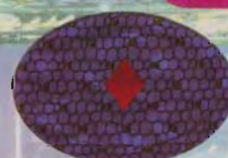

SCHEDULE OF PUBLICATION DATES

1st Quarter: Jan., Feb., Mar.
Mailing Date: Early Jan.

2nd Quarter: Apr., May, June
Mailing Date: Early Apr.

3rd Quarter: July, Aug., Sept.
Mailing Date: Early July

4th Quarter: Oct., Nov., Dec.
Mailing Date: Early Oct.

NOTICE: *“Camera Ready”* advertising deadline is the **1st** of the month prior to mailing date. Please allow 3-4 weeks delivery for 3rd class mail.

FUTURE A.N.A. CONVENTIONS
CLUB MEETINGS
2000 Philadelphia, Pennsylvania
2001 Atlanta, Georgia

ANA BOSTON CONVENTION SITE CHANGED
TO PHILADELPHIA IN 2000

2000 CC>CC 7TH ANNUAL
NATIONAL CONVENTION
TROPICANA HOTEL & CASINO
3801 LAS VEGAS BLVD. SOUTH
LAS VEGAS, NEVADA

CASINO CHIP & TOKEN NEWS
C.C. & G.T.C.C. MAGAZINE
 OFFICIAL Quarterly Publication of
 The Casino Chips & Gaming Tokens
 Collector’s Club

EDITOR
 Kregg Herz
 P.O. Box 1000
 Minden, Nevada 89423

Permission to reproduce in whole or in part is granted provided proper credit is given to the “Casino Chip & Token News”.

Previously unpublished, original articles are encouraged and are welcomed by the Editor. However, no assurance is implied that such material will be used or returned to the author. Proper credit for all materials that are published will be acknowledged.

NO ARTICLES WILL BE PUBLISHED
WITHOUT A BYLINE.

CONTENTS:

President’s Letter 5
Treasurer’s Report 6
Atlantic City 11
California Chips 13
Silver Strikes 15
Riverboat Chips 16
Antique Collectibles 20
Cover Story 22

Membership Application

Casino Chips and Gaming Tokens

Name _____
 Address _____
 City _____
 State, Zip (Country) _____
 Phone _____

My Collection Interests Are:

- Chips Tokens
 U.S. Foreign

I Would Like You To Publish My...

- Name and Address
 Phone
 Do Not Publish My Name
 and Address

I Have Enclosed My Annual Dues For:

- One Year (\$20) U.S.
 Associate (\$ 5) U.S.
 Foreign (\$35) *

* Postal Money Order or U.S. Funds

Check Here
 For First
 Class Postage
 Just \$12
 More a Year



First Class
 Mail

Foreign Mailings are at the First Class rate.
 All other mailings are via 3rd class mail.

Annual dues will be renewable in the same
 quarter in which the membership application
 was processed. Check our address labels for
 your membership expiration dates. Mail your
 completed application with your check made
 payable to CC>CC to:

CC & GTCC MEMBERSHIP OFFICER
JAMES STEFFNER
 P.O. BOX 368
 WELLINGTON, OH 44090

Sponsored By:

CLUB OFFICIALS

Got a question or a problem? Listed below are the names and the addresses of the CC>CC officials and volunteer contacts to whom your requests should be mailed.

- PRESIDENT:** David Sarles
 4680 Greenbriar Rd.
 Williamsville, NY 14221
- Complaints/Suggestions
 By Laws Changes
 Committee Reports**
- VICE-PRESIDENT:** Ken Hallenbeck
 711 N. Nevada Ave
 Colorado Springs, Co 80903
- Chip & Token Update
 New Issues Report**
- TREASURER:** Nate Pincus
 Finances P.O. Box 693
 Bookkeeping Havertown, PA 19083
- SECRETARY:** Barry Weintraub
 Chapter Club Info. 5917 Nagle Ave.
 Van Nuys, CA 91401
- MEMBERSHIP OFFICER:** James S. Steffner
 Club Directory P.O. Box 368
 Address Corrections Wellington, OH 44090

CASINOJIM@prodigy.net
 1-877-4CCGTCC

- EDITOR:** Kregg Herz
 "Chip & Token News" P.O. Box 1000
 Quarterly Magazine Minden, NV 89423
- ADVERTISING
 MANAGER:** Charles T. Rodgers
 "Chip & Token News" P.O. Box 4572
 Lakewood, CA 90711
- 1998 CONVENTION
 CHAIRMAN:** Wayne Thompson
 Dealer Table Contracts 208 Woodspoint Rd.
 Exhibitor Applications Lexington, KY 40502
 Hotel Reservation Cards
- CC>CC CLUB
 PROMOTIONS CHAIRMAN:** Richard Allard
 Commemorative club medals 4016 N. Tanaya Way
 Club chips, logo patches, PMB #123
 Meeting woods, decals Las Vegas, NV 89129
 Back issues club magazine
- PUBLICITY DIRECTOR:** Dennis Zeller
 399 20th Ave.
 Brick,NJ 08724
- CLUB LIBRARIAN:** Robert Pardue
 P.O. Box 2014
 Laguna Hills, CA 92654

**ADVERTISING RATES
CASINO CHIPS & GAMING TOKENS
COLLECTORS CLUB INC.
QUARTERLY PUBLICATION**

These rates are for camera ready display ads only. Need help with your ad? See next column over. Please allow three to four weeks for third class mail delivery.

DISPLAY AD RATES

♣ 1/8 Page	(BUSINESS CARD) Standard size 2" x 3.5"	\$12.00
¼ PAGE	(CAMERA READY) Width of 3.50" x Height of 4.80"	\$22.50
½ PAGE	(CAMERA READY) Width of 7.50" x Height of 4.80"	\$37.50
FULL PAGE	(CAMERA READY) Width of 7.50" x Height of 10.00"	\$60.00
BACK COVER WITH FULL COLOR		\$300.00
INSIDE COVERS WITH FULL COLOR	Width of 7.50" x Height of 10.00"	\$250.00
INSIDE FACEING PAGES	Width of 7.50" x Height of 10.00"	\$100.00

♣NOTE a business card is a BUSINESS CARD not a two inch ad worked up for this space.

CLASSIFIED AD RATES

These rates are for ads per column inch that are up to 3 ½" in width and \$7.50 per inch in Height (about 6 lines) Additional overrun copy will be billed at the rate of \$1.50 per line for less than full inches, or fraction of an inch.

All ad copy must be accompanied by payment made out to "Casino Chips & Gaming Tokens Club Inc." or CC>CC NO ad will be run without payment.

Advertising Manager

Charles T. Rodgers

P. O. Box 4572 – Lakewood, CA. 90711
Phone (562) 408-2463 Fax (562) 634-8107



Editor

Kregg L. Herz

P. O. Box 1000 – Minden, NV. 89423
Phone (702) 782-5681



Publisher assumes no responsibility for statements made by advertisers and reserves the right to reject any advertisement.

SCHEDULE OF PUBLICATION & AD DEADLINE DATES

1 st Quarter: Jan-Feb-Mar	Deadline for ads Dec. 1 st .
2 nd Quarter: Apr-May-Jun.	Deadline for ads Mar. 1 st .
3 rd Quarter: Jul-Aug-Sep.	Deadline for ads Jun. 1 st .
4 th Quarter: Oct-Nov-Dec.	Deadline for ads Sep. 1 st .

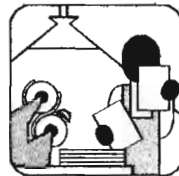

We need your help!,
In publishing
This newsletter.



PLEASE NOTICE

♣Send in your ads as soon as you can for the next issue of the club magazine. Note the deadline. The deadline is the last date we can accept your ads, so don't call in on the 12th of the month after the deadline and expect to have your ads placed in the magazine, we just can't do it.

♣All ads must have your membership number and name someplace in the ad.

♣Do not send in ads that are folded. May we recommend that you send in your ads by Priority Mil in a flat pack marked "DO NOT BEND", this will only cost you about \$3.00 and we will receive them in about two to three days.

♣When you place a one inch or two inch ad for more than one issue, you may make changes in that ad for each issue. Once again try to get the changes to us well before the deadline of each issue.

♣Need help with placing an ad, size wording, give me a call at 562-408-2463 and we will work with you for the best results on placing your ads.

♣When ordering items from one of our advertiser let them know what issue of the magazine you noticed their ad in.

♣Send full payment made out to
"CC>CC" with your advertisement to

**Charles T. Rodgers
Advertising Manager CC>CC
P. O. Box 4572
Lakewood, CA. 90711**

**NEXT DEADLINE
4th . Quarter Issue 2000
is Sept. 1st 2000**



**CONTRACT
DISCOUNT
ADVERTISING
RATES**



Sign up for a full year of advertising and save up to 25% on some ads. Take a look at the table below and see how much you will save.

Contract Discount Advertising Rates			
Ad Size	One Time	Full Year	You Save
1"	\$7.50	\$23.50	\$6.50 21%
2"	\$15.00	\$45.00	\$15.00 25%
Business Card	\$12.00	\$36.00	\$12.00 25%
1/4 Page	\$22.50	\$76.50	\$13.50 15%
1/2 Page	\$37.50	\$125.00	\$25.00 16%
Full Page	\$60.00	\$200.00	\$40.00 16%

Full payment must be sent in with your contract ad request. Just check off the type of ad you would like. You make changes in any of these ads in each quarter of issue.

Yes I Would like	Ad Size	Requirements
	1"	\$23.50 with placement of ad
	2"	\$45.00 with placement of ad
	Business Card	\$36.00 with placement of ad
	1/4 Page	\$76.50 with placement of ad
	1/2 Page	\$125.00 with placement of ad
	Full Page	\$200.00 with placement of ad

Name _____

Address _____

City _____

State _____ Zip _____

CC>CC # _____

Need help in working up you ad? Just give us a call at 562-408-2463 and ask for C.T. Rodgers
Fax is 562-634-8107
E-Mail is ctcoins@aol.com

♣ Send full payment made out to "CC>CC" with your advertisement to

Charles T. Rodgers
Advertising Manager CC>CC
P. O. Box 4572
Lakewood, CA. 90711

OUR CLUB C.C.&G.T.C.C. is founded under the ANA, maybe you would like to join it too. It is the largest organization of coin collectors in the world.

**Application for Membership
American Numismatic Association**

Regular Student Junior Senior Associate

Present or former ANA number, if any _____

Mr. Mrs. Ms.

Name Please Print _____

Street _____

City _____

State _____

Zip _____

Country _____

Date of Birth _____

ANA bylaws require the publication of each applicant's name and state.

Please check here if you DO NOT want your name and address forwarded to the ANA representative in your area.

Please check here if you would like your name provided to companies with offers we feel may interest you.

I herewith make application for membership in the American Numismatic association, subject to the Bylaws of said Association. I also agree to abide by the Code of Ethics adopted by the Association.

Signature of Applicant _____

Date _____

Proposer

Casino Chips & Gaming Tokens Collectors Club

Check MO Credit Card Type _____

Credit Card all Numbers _____

Ex. Date _____

Signature of Cardholder (required) _____

DUES Reg. (age 23-64) \$29 * outside US \$36 *
Student (age 18-22) \$11 Junior (age 17 or younger) \$11
Senior Citizen (age 65 older) \$25* outside US \$32*
Associate (child or spouse of regular or life member living at member's address) \$4

*plus \$6 application fee, first year only

Forward completed application to

ANA

818 Cascade Ave.

Colorado Springs, Co. 80903-3279

President's Letter David Sarles



Well, it's that time of year again. The sun is shining, the kid's are swimming, and the chippers are chipping. Summer means it's time for our annual CC>CC convention. What an event it is! All year long this is the most anticipated week in our hobby. With the excitement of Las Vegas as a backdrop, we venture forth in search of that elusive item we so desperately desire. The true excitement of our hobby is the hunt, and capture of a missing piece to our collecting puzzle. May each of us find our holy grail at this years convention.

Please remember we are an educational organization. Make time to attend our fine seminars and exhibits. A lot of time and hard work by your fellow members goes into these presentations. Plan ahead to fit them into your schedule.

Another opportunity to support our hobby is coming up in August. The annual ANA convention is in Philadelphia this year. Many of your fellow club members will be there. Archie and Brenda Black will be manning a club table for us. Remember we are the largest specialty club affiliated with the ANA. The dates are Aug 10th - 13th, check it out.

A fond farewell goes out to Kregg Herz. Kregg is departing as our magazine editor after this issue. After a long tenure putting out this fine periodical, Kregg will be turning her efforts toward furthering her educa-

tion. I'm sure I speak for the entire membership when I say, Thank You!, Kregg for a job well done! Kregg made many improvements during her term, and I think it shows.

Kregg passes the baton on to John Yee as our new editor. John will be assisted by Allan Anderson. The club is lucky to have such quality individuals step forward and volunteer.

John is president of John Yee marketing in San Francisco. As an independent businessman and entrepenure, John brings much experience to the job.

Allan is a Graphic artist with 23 yrs. Experience in Graphic design.

Both John and Allan are active in the NorCal chapter. They bring a fresh enthusiasm and perspective to our publication. The club can look forward to a new generation of club magazines begging with the fall issue. Welcome aboard John and Allan!

Election time is just around the corner. If you, or someone you know is interested in serving on the board, it's time to get started. The nominations will go out in the winter (Jan, Feb, Mar) issue. It's not too early to start a campaign. If you were thinking of throwing your hat in the ring, now's the time.

Next issue we'll report on all the fun and festivities at our 8th annual convention.

Hope to see you there!

David

TREASURER'S REPORT

Summer, 2000

As of June 2, 2000, the balance in the club's operating account was \$37,478.00 Included in the expenses for the past quarter is payment for the printing, mailing and postage for the Spring, 2000 issue of our club magazine and payments in advance for our convention security, club chips and tokens, table rental and auction catalog expenses. Club revenues during the past quarter included \$15,133.00 for dues and first class postage, \$3,890.00 for convention table fees and auction catalogs and \$1,193.00 received for advertising in the club magazine. The balance in our money market account as of May 14, 2000 was \$33,770.00.

I would like to acknowledge a \$100.00 donation to the club from Robert Eisenstadt. Your generosity is greatly appreciated.

I look forward to seeing many of you at our convention at the Tropicana Hotel Casino. To those who I already have met, come say hello. For those who are new or who I have not yet met, please take a moment to introduce yourself to me. I would love to talk about the hobby with you.

Also, anyone willing to offer their services as a volunteer, please let me know. We can always use more help.

Please feel free to contact my by e-mail, telephone or mail with any questions and comments regarding the club's financial position. Thanks again for your continued support.

Nate Pincus, Treasurer

A.C. NEW ISSUES SERVICE

I am now accepting additional subscribers into my popular new issues service for chips and / or tokens. The following is my pricing structure for new chips and tokens as released from the twelve casinos in Atlantic City. You get chips as they are issued in brand new condition and before the price run-up in the secondary market.

A.C. CHIPS:

\$1	chips are priced at	\$3 @
\$2.50	chips are priced at	\$5 @
\$5	chips are priced at	\$8 @
\$10	chips are priced at	\$15 @
\$25	chips are priced at	\$30 @
\$100	chips are priced at	\$110@

A.C. TOKENS:

.10¢	tokens are priced at	.50¢ @
.50¢	tokens are priced at	\$1.50@
\$1	tokens are priced at	\$3 @
\$2	tokens are priced at	\$4 @
\$5	tokens are priced at	\$8 @
\$10	tokens are priced at	\$15 @
\$20	tokens are priced at	\$25 @
\$25	tokens are priced at	\$30 @
\$50	tokens are priced at	\$60 @
\$100	tokens are priced at	\$110 @

Plus reimburse my actual postage/insurance affixed to the shipping package. I don't charge "flat rates" for shipping that boosts your overall cost of the merchandise received, nor do I require an up-front deposit in advance. Simply send your name, address, club membership number and how many of which denominations you would like to receive and I'll do the rest. Each padded envelope shipment will have a billing invoice and will also include my popular, "Atlantic City Newsletter".

Mail your postcard today to:

ARCHIE A. BLACK
P. O. BOX 63
BRICK, NJ. 08723

NEW MEMBERS FOR LAST QUARTER

<u>Memb #</u>	<u>Last</u>	<u>First</u>	<u>State</u>	<u>Sponsor</u>	<u>Memb #</u>	<u>Last</u>	<u>First</u>	<u>State</u>	<u>Sponsor</u>
R - 4607	Thomas	William	NJ	Borenstein, Alan	R - 4680	Ciezki	Mel	WI	Rodgers, Charles
R 4608	Burgel	Richard	NV	Hall of Fame	R 4681	Chamness	Terry	MO	Lueders, Don
R 4609	Rape	Walter	WA	Rodgers, Charlie	R 4682	Wardwell	Trent	UT	Steffner, Jim
R 4610	Vollmer	Roger	IL	Web site	R 4683	Cram	Randy	UT	Chicago Show
R 4611	Delaney	Cheryl	NV	Web site	R 4684	Long	Michael	AZ	
R 4611-A	Delaney	Arthur	NV	Web site	R 4685	Roberts	Randy	AZ	Web site
R 4612	Dykema	Robert	WA	Web site	R 4685-A	Roberts	Linda	AZ	Web site
R 4613	Baker	Richard	IL	Susong, Greg	R 4686	Zacchi	Steven	NV	Web site
R 4614	Scott	Alvin	CA	Weaver, Marvin	R 4686-A	Zacchi	Linda	NV	Web site
R 4615	Works	Ronald	OR	Hoffman, Michael	R 4687	Mancino	Bennie	NV	Web site
R 4616	Bartnowski	Ed	CA	Bartnowski Steve	R 4688	Redman	Richard	TX	Web site
R 4617	Munoz	Luis	TX	Chip Rack	R 4689	Walker	Donald	FL	Hoffman, Ed
R 4618	Ritter	Daryll	TX	Web site	R 4690	Cole	Janel	NV	Web site
R 4619	Narhi	Patricia	MI	Susong, Greg	R 4691	Chew	Kyong	HI	Pfaender, Armin
R 4620	Ivy	Jess	AR	Brock, Steve	R 4692	Richards	James	OH	Rodgers, Charles
R 4621	Kostyo	John	AZ	Web site	R 4693	Rowland	Robert	NV	Gamingchips
R 4622	Miller	Thomas	NC		R 4694	Smiley Jr	Robert	NV	Hall of Fame
R 4623	Carrion	Edward	NY	Hartman, Scott	R 4695	Bettley	Steve	TX	
R 4624	Jones	David	IN	Lueders, Don	R 4698	Haustein	Richard	NJ	Garrity, Richard
R 4625	Falkowski	Vincent	NY	Web site	R 4700	Pomorski	L	MI	Hartman, Scott
R 4626	Gorman	Kyle	MI	Susong, Greg	R 4702	Brelsford	Darrell	MO	
R 4627	Cavin	Randall	NV	Chipguide	R 4703	Esposito	John	NY	Amer Chip Ent
R 4628	Thompson	Greg	NC	Web site	R 4704	Horyna	Dale	UT	Web site
R 4629	Glover	Larry	OH	Hall of Fame	R 4706	Aliperti	Rick	NY	Susong, Greg
R 4630	Juchum	Judi	OH	SS Club	R 4707	Moraz	Suzanne	CA	Starship
R 4631	Bowers	Jerry	NV	Rodgers, Charles	R 4708	Magiera	Fred	FL	Hall of Fame
R 4632	Kalwarczyk	Robert	MI	SS Club	R 4710	Schwartz	Jerry	ID	Web site
R 4633	Sweezey	Fred	IN	Chicago	R 4711	Cole	Carl	CA	Web site
R 4634	Norgard	Ernie	WA	Hartman, Scott	R 4712	Powell	David	TX	Nezhoda, Rene
R 4635	Bambas	Dan	IL	Web site	R 4713	Bacon	Marty	CA	Web site
R 4637	Mihelich	Sue	MI	Susong, Greg	R 4716	Blass	Paul	NC	Web site
R 4639	Losey	Ronald	NV	Lueders, Don	R 4717	Watkins	Mike	TX	Susong, Greg
R 4639-A	Losey	Adam	NV	Lueders, Don	R 4718	Laird	Jay	TX	Lueders, Don
R 4640	Stork	John	NV	Hall of Fame	R 4719	Baker	Nathaniel	TN	Borenstein, Alan
R 4642	Goldman	Tony	CA	Chip Rack	R 4720	Ulmer	Jerry Don	TX	Rodgers, Charles
R 4643	Bainbridge	Lyle	MT	Hodges, Rich	R 4721	Markus	David	NY	Myers, Allan
R 4644	Garnity	Raymond	NY	Sepe, Joseph	R 4722	Haas	Michael	PA	Web site
R 4645	Bloom	Wayne	NJ	Zeller, Dennis	R 4724	Quilla III	Peter	FL	Richter, Michael
R 4646	Dilulo	Daniel	CA	Knapp, Michael	R 4725	Deason	Tom	AZ	Web site
R 4647	Linke	Marvin	NM	Lueders, Don	R 4726	Leal	Joe	OH	
R 4648	Miller	William	VA	Weaver, Marvin	R 4727	Nelson	Roy	CA	Hall of Fame
R 4649	Walker	Donna	IL	Steffner, Jim	R 4728	Hart	Bob	CA	Herz, Howard
R 4650	Cullen	Shirley	NH	Susong, Greg	R 4729	Olivia	Michael	NJ	Black, Archie
R 4651	Kimble	Kenneth	NJ	Susong, Greg	R 4730	Allen	Mike	CA	Nor-Cal-Nev
R 4652	Mackenzie	Craig	NJ	Web site	R 4732	Schaeffer	Howard	TX	Web site
R 4654	Allen	Jim	OH	Steffner, Jim	R 4733	Swaney	David	DE	Rodgers, Charles
R 4655	Allen	Charles	VA	Knapp, Michael	R 4734	Estes	Bee	NV	Allard, Richard
R 4656	Frediani	Tony	CA	Nor-Cal-Nev	R 4735	Weisenbach	Jerry	FL	Nesbitt, Don
R 4657	Par	Michael	AZ	Web site	R 4736	Weaver	Jim	MO	Susong, Greg
R 4658	Skyberg	Chris	WA	Sanford, Michael	R 4738	Hartinger	Ron	CA	SS Club
R 4660	Calhoun	George	TX	Web site	R 4739	Hall	John	WA	Web site
R 4661	Erickson	Mark	OR	Susong, Greg	R 4740	Marshall	Danny	UT	Weaver, Marvin
R 4662	Sikes	Thomas	FL	Hoffman, Michael	R 4761	Sill	Glenda	KS	Steffner, Jim
R 4663	West	Steve	IL	Hall of Fame	R 4761-A	Sill	Charlie	KS	Steffner, Jim
R 4664	Tan	Leonidas	NJ	Web site					
R 4665	Davis	John	CA	Hartman, Scott					
R 4667	Prentice	John	IL	Massimiani, John					
R 4668	Walker	Don	WI	Herz, Howard					
R 4669	Garcia	Frank	OH	Steffner, Jim					
R 4672	Garzino	Don	NY	Web site					
R 4673	Witcomb	Tom	FL	Benedict, John					
R 4674	Brooks	William	CA	SS Club					
R 4675	Gaito	James	CA						
R 4675-A	Gaito	Chris	CA						
R 4676	Phillips	Mike	MO	Mortimer, Randy					
R 4677	Capitano	Sam	FL	Chip Rack					
R 4678	Martorana	Frank	FL	Smolkin, Sam					

JUNE RENEWALS

RENEW by MAIL

**Don't Be Left Standing
in the Hall at the Convention**

Need more collecting activities? Join a Chapter!

by Charles Kaplan, R-2558

Casino chip, token and memorabilia collecting is a fast growing hobby. We all know that the annual CC>CC convention is the highlight of the year. But what is there to do the rest of the year to build your collection and relate with other collectors?

For those of us who are connected to the Internet, there many activities that you can participate in daily. You can visit chip auction sites, converse with other chippers on the Club's Bulletin Board or on Greg Susong's ChipBoard, read articles about chipping on Chequers or visit other chippers web sites to look at their trade and sale lists.

If you are lucky enough to live near one, you can attend a Chip Show. There are shows regularly held in Las Vegas and Southern California. There have been others held from time to time in Biloxi, Chicago, Ocean City, NJ, and Northern Nevada. Occasionally you can also pick up chips at a coin or antique show. Finally, you can go on a chip run.

Well what else is there to do? Join a chapter! There are many chapters of the CC>CC all around the country. Some are very active and have meetings scheduled every month, others meet every other month or perhaps less often. The Atlantic City chapter is the largest with over 300 members. The bimonthly meetings attract over 100 members for trading, sales, auction, raffles and presentations from various speakers in the hobby or casino industry. The smallest chapter, that I know of, is the New York State chapter that started out with only 5 members. You don't have to be big to have fun.

How do you locate a chapter near you? I've compiled a list of casino chip chapters or clubs from various sources. The information is tough to keep current and I would appreciate any updates to the list. Please send them to me at ckaplan@attglobal.net. The list is available on-line, with hot links to chapter web sites as well as Email links to the contacts, at the NY Metro web site:

www.ccgccc.com/chapters/nymetro

If you are not on-line, you can write or call the chapter contact to find out when the chapter meets and what to expect when you attend a meeting. Most chapters have minimal dues, \$5.00 or so a year, just to cover the cost to mail meeting notices.

What if there isn't a chapter near you? Start your own chapter! It's no big deal. First, contact the club's Membership Officer, James Steffner. He can provide you with the requirements for starting a chapter and a list of club members in your area. The biggest concern is finding a place to meet. My chapter's first meeting was at my home. When we decided to form the chapter and needed a better meeting location, one of our members volunteered his American Legion Hall for our bimonthly meetings. If there is a nearby casino, most are happy to provide a meeting room for casino related activities at little or no cost.

So if you want chip and token collecting activities all year long, find a nearby chapter or start your own.

Chip Collecting Chapters and Clubs

Atlantic City

Dick Brach (908) 647-0814
32 Olsen Drive, Warren, NJ 07059

California - Northern & Nevada

Todd Dingley (916) 393-6464
6 Sandpointe Court, Sacramento, CA 95831

California - Orange County

Rob McColum (310) 217-9536

California - San Diego

Call Oceans 11 Casino

California - Southern

Armin Pfaender (818) 893-2825
Scott Hartman (800) 582-5707
P.O. Box 387, Agoura Hills, CA

Colorado

Lee Bruton (303) 279-1299
176 Sagebrush Street, Golden, CO 80401

Florida

Mark Lighterman (305) 595-7086
9230 SW 59th Street, Miami, FL 33173

Great Lakes

Albert Scalzo (810) 794-3378
7229 Flamingo, Algonac, MI 48001
Jim Smith (734) 439-2510

Kansas City

Jim Kruse (816) 420-8590

Las Vegas

Jerry O'Neal (702) 222-1889
Debbie Harber
613 Mayfield Street, Las Vegas, NV 89107

Mid-America Chip Collectors Club

Mark Menke
1107 SW 24th Street
Blue Springs, MO 64015

New York Metro

Charles Kaplan (516) 763-2327
11 Calais Court, Rockville Centre, NY 11570

New York State

Amy Andrae
6361 Jane Lane, Cicero, NY 13039

Silver Strikers

Jack Haddock
P.O. Box 7544, Reno NV 89510

Texas

Vern Blanck (713) 587-0734
P.O. Box 90097, Houston, TX 77290
Ed Hertel (281) 499-3510

Washington

Jim Forsman (425) 747-6662



**OVER 1300
Color Photos**

This is a complete guide to the chips of
The more than 100 American
Riverboat Casinos It includes pricing,
Detailed information, and full color
Photos of each chip. Buy the book
BEFORE you buy the chip!

Order Now!

Send \$32.95 + \$3.20 priority postage to:

Greg Susong
P. O. Box 654
Wellington, KS. 67152

CC>CC R-212

*An Illustrated Guide To
The Casino Chips Of
American Riverboats*

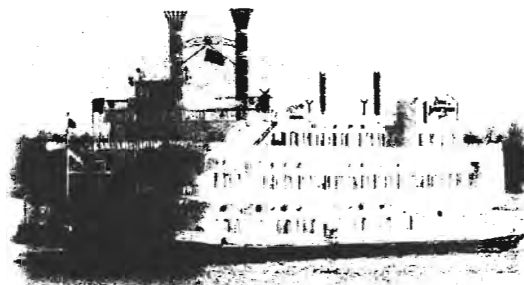

By Greg C. Susong

BUYING IVORY GAMBLING CHIPS

I WILL ALSO TRADE ANY CASINO CHIPS ON MY LIST FOR IVORY POKER CHIPS I CAN USE
PLEASE SEND A CLEAR PHOTOCOPY OR AN ACTUAL CHIP FOR REVIEW



IF YOU SHOULD COME ACROSS ANY IVORY GAMBLING CHIPS WHILE
SEARCHING FOR CASINO CHIPS, PLEASE CALL ME

TOLL-FREE: 1-800-844-3397

"I'm Always Buying Ivory Poker Chips"

YOU CAN ALSO FAX ME A PHOTOCOPY "TOLL-FREE"
INCLUDE AT LEAST ONE PHONE NUMBER WHERE YOU MAY BE REACHED

BENEDICT@WEBTV.NET

Thanks!

**JOHN BENEDICT (R-388)
P.O. DRAWER 1423 - LOXAHATCHEE - FLORIDA 33470**



ATLANTIC CITY REPORT

By Archie A. Black HLM-001

My first order of business is to express my sincere personal thanks to out-going club magazine Editor, Gregg Herz, for her devotion and dedication to the club publication and secondly, to offer a warm welcome to the new Editor, John Yee. The club has lost a very talented and innovative Editor in Gregg, but it would appear that a very capable replacement has been found in John. Best wishes to both of you from the Blacks' household.

The highlight of the previous quarter was the release of the now famous Will Espin chip, which brought a top bid of \$102.50 on Ebay and many, many bids between \$50 - \$125 in my A.C. New Issues Service auction. It's still too early to determine where the value of this relatively scarce chip will eventually level out up or down. As of this writing, (mid-May) I have none left for sale in inventory.

Picking up where we left off since the last magazine issue, Claridge continues to be the dominant chip-issuing leader in Atlantic City. An issue of 1,000 \$5 and 500 \$10 St. Patrick's Day chip were released in March from a specially designated roulette table.

Also in March, A.C. chippers saw a Taj Mahal \$100 Millennium chip of only 100 in quantity offered. I was extended an opportunity to purchase a stack of 20 chips to be distributed at face value to those in attendance at the Atlantic City Chapter March meeting. When those in attendance were asked to stand if they collected \$100 A.C. chips, only 14 stood up and each were given a slip of paper that could be exchanged with \$100 cash for the new "The Donald" millennium chip. In addition, three names were also drawn at random from a hat for three additional chips awarded to the rest of the members in attendance who expressed interest in purchasing the \$100 millennium chip at face value.

April was a very quiet month, as no chips were issued in A.C. until the very end of the month. Claridge issued the first of eight Lighthouse series chips. The first chips, again a \$5 and \$10 denomination in 1,000 and 500 quantities respectively, featured the Fire Island New York Lighthouse. The

2nd chip in the series was nearby Barnegat Lighthouse, Long Beach Island, NJ, which was issued in late May. Tentatively scheduled for release are the following: Sandy Hook Lighthouse (New Jersey) in June; Absecon Lighthouse (Atlantic City) in July; Cape May Lighthouse (NJ) in August; Thomas Point Lighthouse (Maryland) in September; Seven Fort Knoll Lighthouse (Baltimore) in October; and finishing up the series in November will be the Sandy Point Shoal Lighthouse (Maryland). All \$5 chips are to be issued in quantities of 1,000 while the \$10 chips will have issues of just 500.

A surprise variation of an existing chip was reported by Russell Diaz, of Brigantine. It would appear that the \$1 Harrah's Marina regular table chip has been re-issued. The "i" in Marina and "i" in Casino are completely different (smaller) on the new version compared to the i's on the older original chips. Additionally, if both chips are viewed outdoors in broad daylight with the naked eye, the newer "mini-i chip" will have a violet-purple hue to the otherwise gray ring surrounding the metal center.

For the A.C. token collectors; we have finally found something to maintain interest in our collections. A brand new \$2 slot token has been issued at Tropicana. The older TropWorld \$2 tokens have all been removed from play.

I'm also told, by a very knowledgeable slot attendant, that .50 tokens at Trop are on the way. Another casino in town succumbs to the elimination of Kennedy half-dollars. I'm reasonably certain that more casinos will follow suit and change over their 50 machines to accept .50 tokens instead of half-dollars.

Chippers are patiently awaiting the release of a \$5 & \$10 4th of July issue from Claridge; a \$10 Van Halen chip in their "Rock The Dock Series" at Trump Marina; and a \$5 Chinese New Year chip issue at Trump's Taj Mahal.

Hope to see many of you at the 8th Annual Convention in Las Vegas this July.

WANTED

For Cash: Your loose chips, individual chips, or complete collections!

TOLL FREE (800) LUCK - 707



Maryland
Fire
Department

8 Chips Only
\$75.00
(Includes S&H)



SCOTT HARTMAN — "THE CHIP MAN"

P.O. Box 387, Agoura Hills, California 91376-0387

Tel: (818) 706-1197 / Fax: (818) 706-1986

Web: <http://www.chipman.com> E-Mail: scott@chipman.com

* Orders under \$50 please add \$3 Shipping & Handling *

California Chips

By David Moore

R-4214

Probably the biggest chip news in the Golden State during the last quarter is that the Viejas Indians, who operate a casino near San Diego, began operating a gambling ship in April. The ship is the MV Enchanted Sun, operated by Commodore Cruise Lines, and traveled from San Diego to Rosarita Beach in Baja California. The Bud Jones chips are in denominations of \$100, \$25, \$5 and \$1. The ship also uses a \$1 gold-tone token and a 25 cent silver-tone token. The boat suspended service due to lack of customers on June 2 after only seven weeks of operation. Part of the problem was the ship was supposed to dock at the Rosarita Beach hotel but high swells prevented this. One report said the Viejas tribe had invested \$8 million in the gambling ship scheme.



The cardroom in the Lake Bowl in Folsom, which closed late last year, has reopened with a new rack with a bowling design. Most collectors seem to like the old Suicide King chips better.

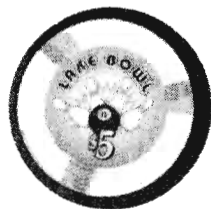

The Saigon Casino in Stockton has issued a \$5 chip with a Suicide King design on one side and Pai Gow tiles on the reverse. No word as of this writing on other chips from the club.



Garden City and Bay 101 have been threatened with being closed down by the city of San Jose. A number of employees were arrested at each club on various charges related to alleged loan sharking going on at the casinos. Garden City changed their \$1 chip from their new rack. Apparently the purple color was coming off on player's hands so it was replaced with a blue chip of the same design and a slightly smaller inlay.

Lucky Chances in Colma called back their new Bud Jones greenish \$100 chip when it was discovered that the Oaks in Emeryville is using a \$3 chip that looked exactly like it in a stack or rack. For now, they have gone back to the old Chipcos for all denominations except for the \$20, which is the new Bud Jones. Expect to see all the Lucky Chances chips change to the Bud Jones before long, though. Not sure if any of the green \$100s got out. Aren't too many collectors of California \$100s so it seem doubtful many exist.

Two new California casinos should be open by next quarter's magazine: Larry Flynt's Hustler Casino in Gardena and The Palace Indian Gaming Center in Lemoore.

If I've missed a new chip issued in the last three months or if you know of upcoming California chips, drop me a line, and I'll include them in the next issue of the club magazine. Contact me at: moored@pacbell.net or write: David Moore, 1750 San Luis Road, Walnut Creek, CA 94596.

Cassidy Chip Frames

Give your chips the prominence they deserve! Our solid wood frame is a beautiful black satin color; a clean and stately design that prominently displays and accentuates your chips. Share your hobby and create a beautiful display for yourself, friends and family. Visit our web site (www.cassidyframes.com) to see all our products or call to request our **brand new catalog**, full of items!

- High-quality solid wood molding in **BLACK** laquer. (5x5 frame has Gold w/ Silver highlight wood frame)
 - Clear **ACRYLIC** to protect your chips.
 - Sturdy 3/16" foam core backer board.
 - Heavy Duty Spring Clips for quick installation. (Except 8x10; has open-door easel back)
 - Choice of **THREE** velvet board colors. (see below)
- Frames** 5x5 - \$14.95 11x14 - \$34.95
 8x10 - \$23.95 16x20 - \$49.95
 9x12 - \$27.95

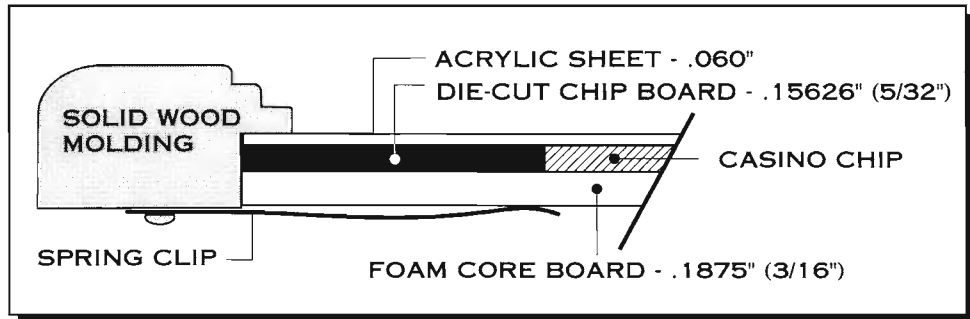

Crystal Clear Acrylic

All of our frames come equipped with a crystal clear .060" acrylic (Lucite) front, which has many advantages over glass. One clear advantage over glass is that acrylic will not shatter like glass can, thus being much safer to handle and ship. Another advantage being the protection it provides your chips from the harm light can cause. Our acrylic naturally filters out 45% of Ultraviolet rays to prevent your chips from the effects of light.

Acrylic 5x5 - \$1.25 11x14 - \$5.95
 8x10 - \$2.95 16x20 - \$7.95
 9x12 - \$3.95

Velvet Display Boards

Save money and use your own frame by purchasing our velvet display boards (with sturdy 3/16" foam core backer). Die cut for a perfect 39mm (standard chip) fit and available in your choice of Jet **Black**, Emerald **Green** and Winter **White**! These are an unbeatable value! Order yours TODAY!

16"x 20" (63 chips) **\$13.95**

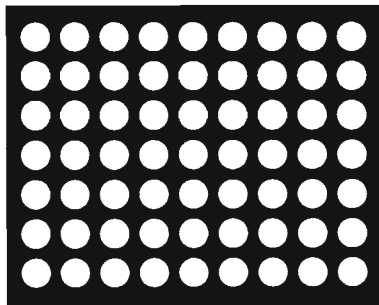

11"x 14" (30 chips) **\$9.95**

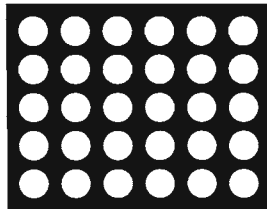

9"x 12" (20 chips) **\$7.95**

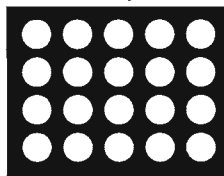

8"x 10" - 2 styles **\$5.95**
 (12 chip & 14 chip + 3.5"x 5.5" window)

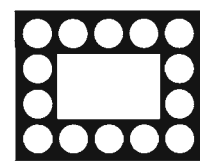
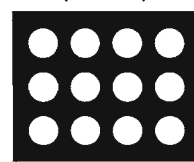

5"x 5" - 4 chips **\$2.95**



Visit our website: WWW.CASSIDYFRAMES.COM

ITEM DESCRIPTION	SIZE	BOARD COLOR	QTY.	ITEM PRICE	PRICE

PACKAGE SHIPPING & HANDLING	
Up to \$5	add \$1
\$5.01 to \$20	add \$3
\$20.01 to \$30	add \$5
\$30.01 to \$50	add \$7
\$50.01 to \$70	add \$9
Over \$70.01	add \$11

MERCHANDISE TOTAL	
SHIPPING & HANDLING	
MA RESIDENTS ADD 5% SALES TAX	
TOTAL AMOUNT DUE	

METHOD OF PAYMENT Check or Money Order
 Visa Mastercard Discover American Express

YOUR CARD NUMBER

We won't charge your card until we ship! Expiration Date

Signature

Billing Address

Name

c/o

Address

City State Zip

Personalized Brass Nameplate

There are many other newer products, like our personalized engraved nameplates, which help you personalize your display while adding a touch of elegance! They are solid brushed brass with a durable peel and stick adhesive backing. Choice of 3 typeface format! We're offering it at only \$7.95 with additional nameplates only \$5.95 (when accompanying initial \$7.95 nameplate purchase; Allow additional time for processing. Price includes shipping!)



BRASS PERSONALIZED NAMEPLATE FORM

Please print clearly (Use separate piece of paper for additional nameplates)

Quantity \$7.95 (additional nameplates only \$5.95)

Roman typestyle Upper/Lowercase All Caps U/L (small caps)

Upper/Lowercase - Typestyle Example
 All Caps - TYPESTYLE EXAMPLE
 U/L Small Caps - TYPESTYLE EXAMPLE

Prices includes 24 characters.
 Additional letters: 25¢ each.
 Please allow additional time for processing.
 Sorry, no refunds on engraved nameplates.



Call Toll Free
1-800-941-4491

24 Hour Fax Number
1-508-829-3415

24 Hours a Day • 7 Days a Week

Cassidy Frames
 P. O. Box 157
 West Boylston, MA 01583-0157

Jim Cassidy
 CC>CC Member #1221

The excitement is building as we get ready to attend the second Silver Strikers convention in Las Vegas. Oh, alright, I guess it is in conjunction with the CC>CC. What a thrill for all of us to go out there this year with our own chapter up and running. Over two hundred silver strike members are nothing to shake a stick at! We should all be very proud of what we have accomplished.

My husband and I were over to Prairie Meadows at Altoona, Iowa right after they took out the \$200 silver strikes. What a disappointment! They said that they will redeem them until August and also would sell any that are turned in within that time frame. They warned us that the strikes might not be turned in with their boxes. I believe that was the last place where you could actually play a machine to get a \$200 strike.

In the last issue I mentioned that Nebraska had a bill before the legislature to allow gambling on the Indian reservations. The bill was not passed as once again the Great White Fathers and Mothers declined to let slot machines be legal under any definition in Nebraska. So we play the lotto, bet on the horses and buy all the pickle tickets we want, but we are not to soil our hands on those evil slot machines. Course most of us Nebraskans take our money and drive over to Council Bluffs and play slots there to our heart's content. The only problem is that they do not have strikes.

On the subject of Council Bluffs, Harvey's Casino has purchased Bluffs Run Casino and Dog Track. Bluffs Run is retaining its name, but that is two against one for the Ameristar Casino.

The Lake Shore Casino in Osceola, Iowa has been operating since January. They were

delayed opening because the lake was not deep enough to float the boat and they had to do more dredging. I went to high school in Osceola and it seems very strange to see that boat sitting on that pond.

Ray Moritz gave me an update on what is happening in Missouri with the casinos there.

The Flamingo Hilton in Kansas City was in trouble for bribing an official of the Kansas City Port Authority. The State Gaming Commission forced Flamingo to sell. Donald Trump tried to buy it, but the Commission rejected his license application. The Station Casino made a bid but later withdrew it. Now the Isle of Capri will be taking over the Flamingo effective June 5, 2000. They also have an application for license to build a casino in Booneville, Missouri as well as one in St. Louis County.

Harrah's had purchased Sam's Town and then closed it, hoping to increase their market share of the Kansas City gaming business. It didn't work. In the St. Louis area, they bought the Players Island Casino.

All this jockeying around leaves only President on the Admiral, St. Louis and St. Joseph's Frontier Casino at St. Joseph as not having changed ownership.

We want to encourage all of you to send in your stories and information to the Silver Strikers Newsletter and also this magazine. Most people write better than they think they do, but if this is holding you back, send me an outline and I will type it up for you.

Signing off until next time and wishing all of you the best time in Vegas. Have your trades ready and your Silver Striker shirt on.

Riverboat Chips

By Greg Susong R-2120
Email: greg@chipguide.com

Sometime in March, Boomtown Casino in Biloxi, Mississippi started using this yellow, unicorn mold .25.



Lakeside Casino in Osceola, Iowa released their Grand Opening chip late in March.



Hollywood Casino in Tunica, Mississippi put new \$2.50's on the tables. They are very similar in design to the last issue, which are on the tables also, but the new ones have an updated font design that makes them easier to read.



Diamond Jo in Dubuque, IA issued their very first commemorative chip to

celebrate an Oak Ridge Boys concert on April 6, 2000.



A surprise came from the Isle of Capri, Bossier City, LA. It was late April before I learned they had issued \$5, \$25 and \$100 chips for the millennium.



The Grand Casinos in Biloxi and Gulfport, Mississippi each issued a 3 chip set to commemorate the appearance of Pavarotti on April 29th. Each casino issued nearly

identical \$5, \$25 and \$100 Chipcos with only very slight differences.



Riverboat Chips



Hollywood Casino in Aurora, Illinois put their backup set of \$5 chips in play and removed the original set.

You can always view the chips shown, and more than 5,000 others online at ChipGuide.Com. Just point your browser to:

<http://www.chipguide.com>

THE SLOT CARD BOOK

Over 1000 different front and back color pictures of slot club cards from casinos around the country. A must have book for the newest and fastest growing casino collectible.

Send \$29.95 plus \$3.20 for U.S. postage to:

Carolyn Donley
The Slot Card Book
P.O. Box 80572
Las Vegas NV 89180

CC>CC #R-380A

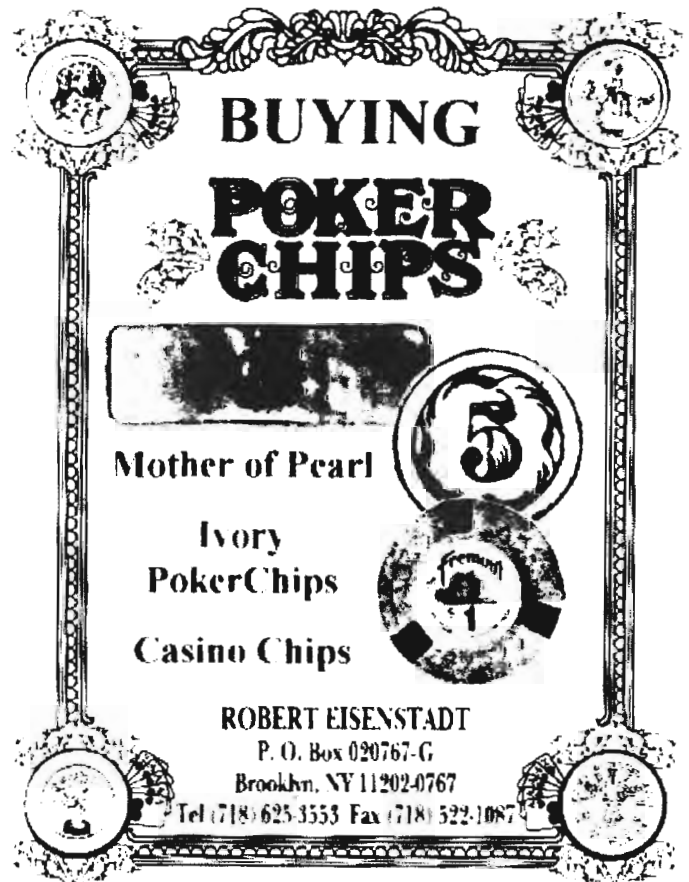

BUYING POKER CHIPS



Mother of Pearl

Ivory

PokerChips

Casino Chips



ROBERT EISENSTADT
P. O. Box 020767-G
Brooklyn, NY 11202-0767
Tel (718) 625-3553 Fax (718) 522-1087

SUPPLIES

For the

CHIP & TOKEN COLLECTOR

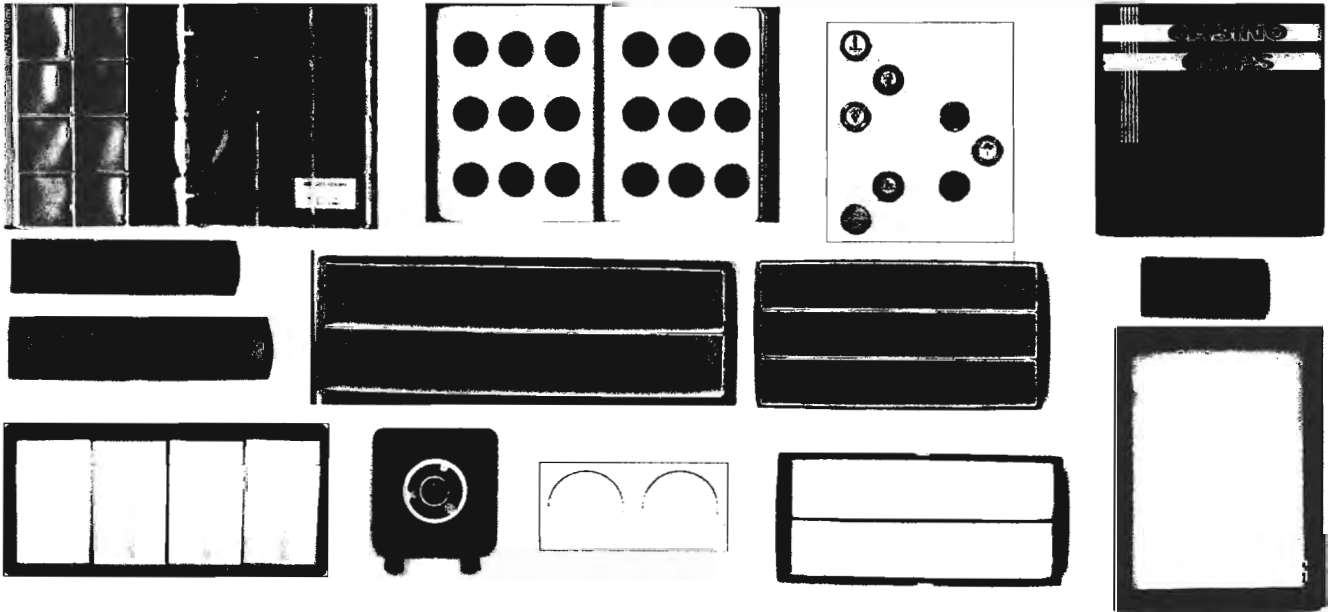

Binders 7 or 9 page from Dansco , Pages 12-20-30 pocket, Match book and Post Card pages, Storage Boxes of all types for 2 x 2 , 2 1/2 x 2 1/2 or not in holders,, Storage Tubes, Display frames. Display cases 6 x 8, 8 x 12, 12 x 16, Flips & Holders 2 x 2 ,2 1/2 x 2 1/2, Chip & Tokens wallets 12, 18, 24, 60 , 80 Pockets, Magnifiers, Informational books of all types, what ever it takes to house your collection! WE WILL HAVE IT.

SUPPLIES 2000

Our supply catalog is fully illustrated with all our products. If you need one, just give us a call or send us your name and mailing address, one will be sent out at once. NO CHARGE It's FREE

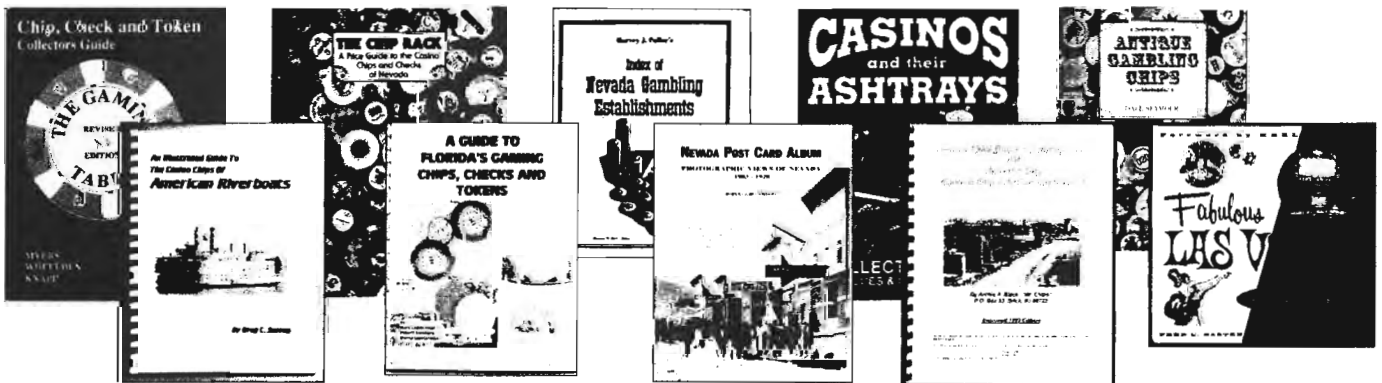

Casino collectibles is our full time business - Serving the collector for over forty five years

Charles & Margarita Rodgers

C. T. COINS - P. O. Box 4572 - Lakewood, CA. 90711

Phone 562-408-2463 - E-Mail ctcoins@aol.com - Fax 562-634-8107

Club Library adds new Casino Guides + More

Also new CD of Seymour's "treasures"
by Robert Pardue (CH-003) – Club Librarian

New Additions to the Library

After a quiet quarter for new materials last time, the library has several new additions that members will be interested in. And we have some additional donations of back-up guides, important for historical reference.

Black's Atlantic City 2000 guide

The popular guide to Atlantic City chips & tokens has been updated and contributed by club founder Archie Black. The new guide includes new items released in 1999, and an updated price guide. Always in demand by library users.

Cheques, Chips and Tokens of Playboy Casinos

Tom Stroh has published and donated an interesting 80-page booklet on Playboy casino collectibles around the world. Includes commentary, descriptions, color photos and checklists...everything the specialty collector needs to know about gambling collectibles used in the Playboy casinos.

Dale Seymour's "treasures" CD from HGTV

Thanks to Dick Covington for the professional job he did in "burning" a CD of the tour of Dale Seymour's collectibles seen on HGTV in March 2000. Features some of Seymour's beautiful ivory & antique chips from around the world. Play this CD on your computer. Thanks, Dick, for capturing this interview for other collectors to enjoy.

Additional Donations

If you're interested in the history of the Moulin Rouge (Las Vegas), we received an interesting 9-page article titled "Viva Black Vegas" from the November 1999 issue of Los Angeles Magazine. Include stories and pictures about the casino and the entertainers that made this place unique.

In the past quarter we also received extra earlier editions to The Chip Rack -- 3rd edition (1996) and 4th edition (1997), which should be useful for future historians tracking the changes in value and availability of Nevada chips. Also received extra copies of the club magazine for the period Fall 1996 to Winter 2000. And remember, we continue to receive current issues of the club magazine and the monthly ANA "The Numismatist" for the library.

Check-out procedures

As a reminder, club members in good standing may check out up to 4 items at a time for 3 weeks; renewable for 2 extra weeks if item is not on a waiting list. Make requests by email (preferred) or regular mail. Club pays postage to you; you pay return postage. It's that simple!

Robert Pardue
CC>CC Librarian
P.O. Box 2014
Laguna Hills, CA 92654

Email: pardue@home.com



Above left: the popular Black's Catalog 2000 Edition. Includes updated lists & photos of chips tokens and other Atlantic City collectibles.

Above right: Tom Stroh's guide to casino collectibles from the Playboy Casinos around the world. Well researched with color illustrations of many chips & other items.

ANTIQUE COLLECTIBLES
by Dale Seymour & Ken Craig

New Chip Find?

No, this is not a new chip find. It is a big thank you to Kregg Herz, the editor of the *Casino Chip and Token News*. Rumor has it that Kregg will be retiring from that volunteer job after this issue. She has put in countless hours serving chip collectors and we owe her a big "thank you". Next time you see her in person let her know how much you appreciate the work she has done for the club. What are you going to do with all your extra time now, Kregg?



This issue will be devoted to letting you know what new antique chips have recently been found. Both clay and ivory chips seem to be harder to find, but new designs keep appearing.

New Ivory Codes



ID-CZ Tiger
v:r

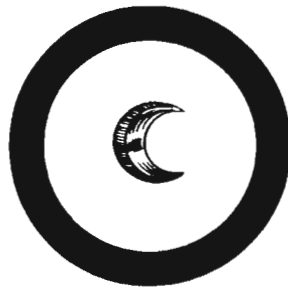

ID-IE Crescent
v:l

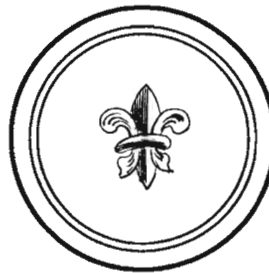

ID-MW Fleur-de-lis
v:k

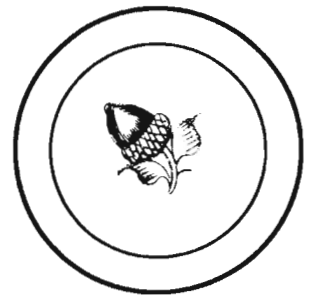

IE-UD Acorn
v:l

Note: We are moving the other two acorn chip codes to a more logical location.

ID-RU to IE-UE and
ID-RT to IE-UEa



IE-PQ Blossom
v:l



IF-DO Eight Border
v:m

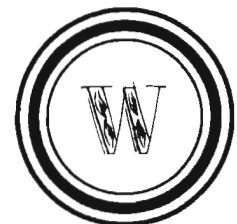

IM-JQ W
v:l

ANTIQUE COLLECTIBLES (Continued)

New Ivory Codes



IN-CJ
3/3/3 / v:l



IN-FH
4/F/3/ v:l



IO-NV
v:n



IO-OG
v:m



IN-PO
v:p



IN-WU
4/F/4/2/ v:l



IO-RK
3/2/4/ v:m



IO-SY
3/F/3/ v:m



IN-ZS
v:l



IO-BV
v:l



IP-DR
3/F/3/2/ v:m



IP-RZ
3/2/3/ v:p



IO-EK
v:m



IO-NA
v:m

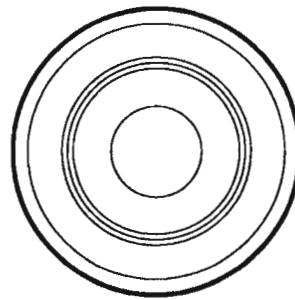

IY-EN
5 B 5 W (38/34) / v:i

note: Ivory \$5 chip shown on this page as new code IN-WU was originally coded as a curved-top chip on page 169 of the revised edition of *Antique Gambling Chips* as IO-CF.

Collecting in the World of French Style Gaming Plaques & Jetons

By Howard W. Herz - LM-3, Ch-85



"*Breaking the Bank at Monte Carlo*" has been the dream of almost every gambler and only in recent years has Las Vegas risen to the level of legend in gaming circles that Monte Carlo once exclusively enjoyed. To collectors who enjoy the uniformity of the 39mm round American style gaming check, French plaques and jetons can be a mystery - but one that offers a great amount of satisfaction in collecting with some understanding and history.

There are two basic styles of gaming that predominate in the world. American Style developed around the game of craps - a fast paced dice game that began in the alleys of areas like East St. Louis, Missouri or New York City. The gaming checks that were developed for American Style were uniformly sized around 1-1/2" to 1-9/16" in diameter.

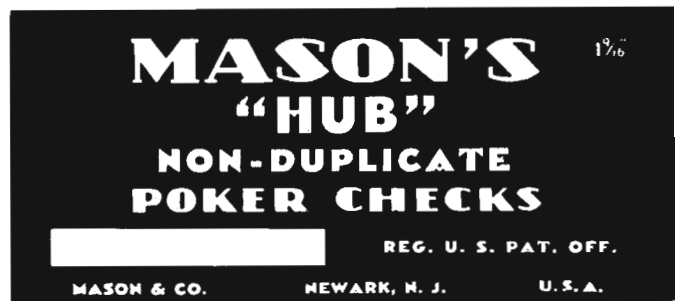

French Style gaming developed in exclusive salons around the games of Chemin de fer and Roulette. The style and atmosphere of the salons reflected leisure and elegance. Players used *jetons* and *plaques* in place of money and these reflected the splendor of the gaming houses.

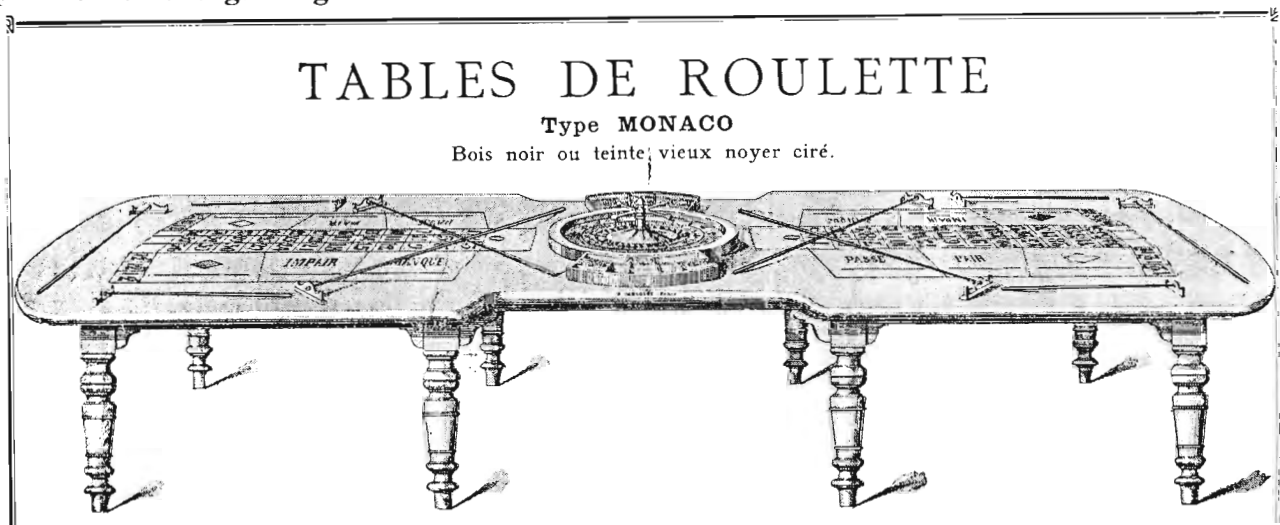

Technically, jetons are round and usually have a diameter between 32mm and 60mm. Plaques are rectangular, oval or square and generally vary in sizes from 38mm to 151mm. French style gaming uses size as well as color to differentiate denominations. Materials of manufacture range from ivory, bone and mother-of-pearl to plastic. Designs are frequently elaborate and beautiful and reflect the elegance associated with French style.



As American gaming spreads around the world, its uniformly sized checks and chips dominate games like craps and blackjack. Where speed is the objective to give the house a more frequent chance at the player's money, only color defines the differences in value. American style gaming is a relatively recent development that has grown since the 1930's. It is French style gaming that has historically been associated with style and class while American Style reflects a sense of wild fun and amusement.

When the Sahara Hotel in Las Vegas sought to introduce the sophisticated game of baccarat in the early 1960's, they originally imitated the French Style and used both jetons and plaques. The game was not a success as customers were used to the fast paced and frantic play that craps generated. The elegant and sophisticated French style seemed to be too slow and the games were withdrawn for lack of players. The Sands Hotel also brought in baccarat with the same results as the Sahara.



In the 1970's and 80's, baccarat was Americanized with the elegant long tables reduced to blackjack size and the play accelerated with American style checks. As the number of international players began to flow to Las Vegas, the large French style tables were again introduced, but the play is not conducted with the elegance and leisure of the last century that prevailed in Monte Carlo - only the size of the bets are legendary.

Despite the inroads that American gaming has made in traditional French style gaming houses, the elegance and flare of jetons and plaques continues to be a draw to collectors. French style jetons and plaques are usually issued in uniform sets with the higher denominations becoming more elaborate. The lack of uniform size may discourage some collectors who like the tidiness of having all of their chips and checks fit in one size holder. The range of color and beauty more than make up for the inconvenience that the size variations cause.

JEU DE KLONDYKE

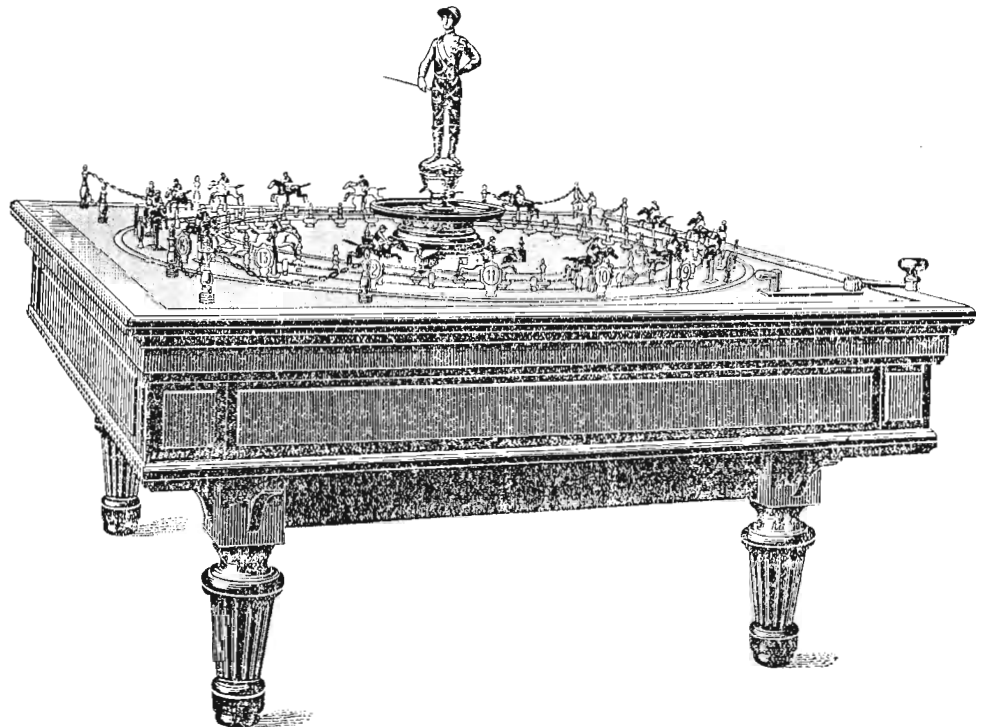

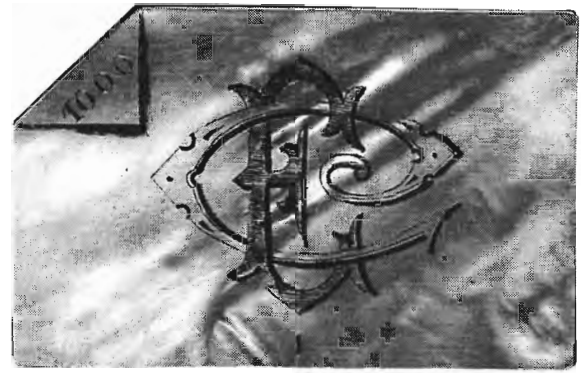

JEUX DE COURSES

dits DE PETITS CHEVAUX

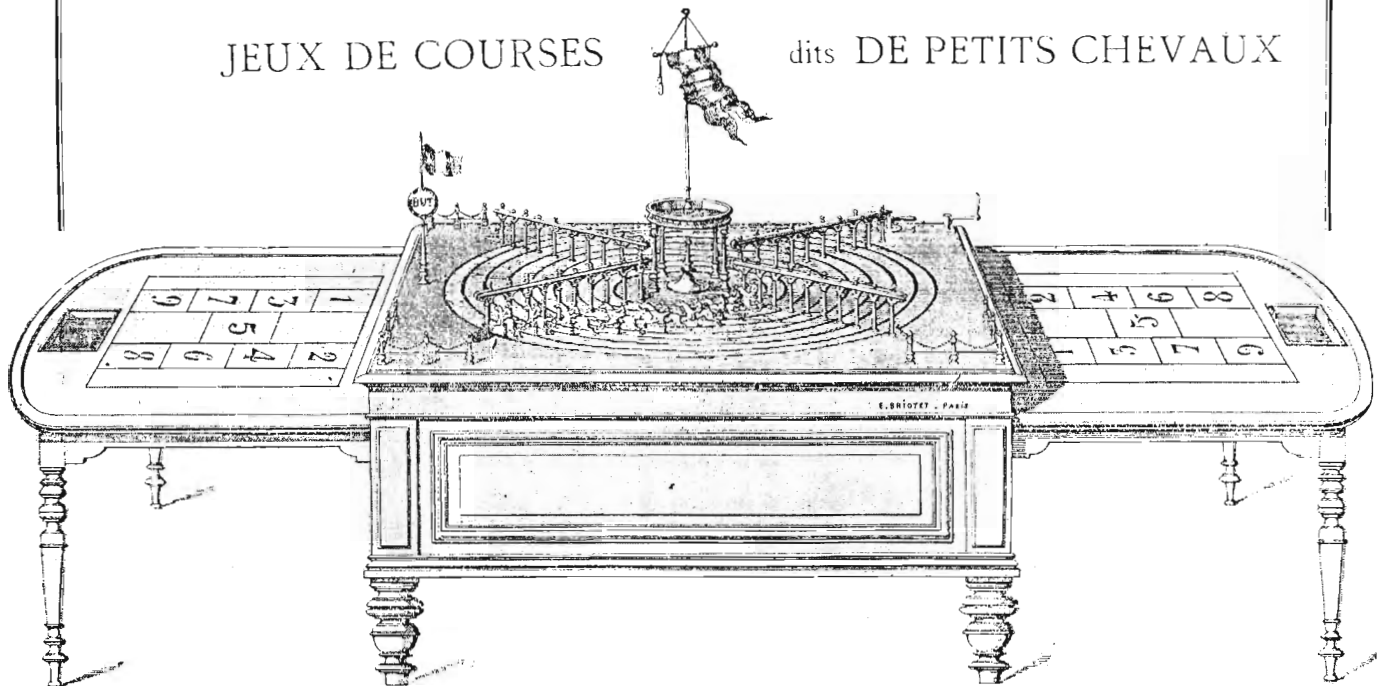

Besides the plastic, ivory and other non-metallic materials, casino jetons can be found in a large number of metals. These metallic "tokens" are an integral part of the money of French style casinos and are as collectible as are the plaques and non-metallic jetons.

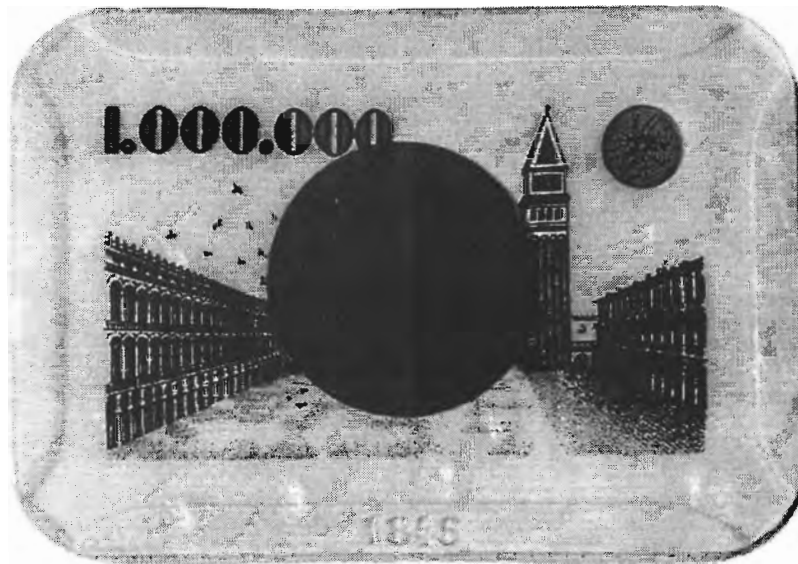

Collectors who wish to accurately describe their French style jetons and plaques are directed to the excellent descriptions that have been reprinted on the inside front and inside back covers of this issue. These descriptions, provided with the permission of *Bourgogne et Grasset* from their catalog, give the basic terminology that the manufacturer uses for the various parts of their jetons and plaques. These catalog reproductions have been reduced by 50%. The illustrations of the gaming equipment from the last century are from the catalog of G. Caro of Paris circa 1900. Additional illustrations are from a G. Caro catalog produced in the mid-1920's. For an exceptional tour of French style gaming markers, go to <http://www.bourgogneetgrasset.fr>!

gamingchips.com



The Premiere Search Site
On The Internet For That Hard
To Find Chip or Token!

If you are a collector or dealer of gaming chips, tokens or related memorabilia, this site has been custom designed with you in mind.

You will want to be listed here!

Join our free banner exchange program and increase your web site traffic.

**Go to www.gamingchips.com
and click on our free banner ad
for more details.**

gamingchips.com P.O. Box 66473 Los Angeles, CA 90066
CC&G7CC #2835

If you...

- ...**CAN'T WAIT** to find out what's new.
- ...need **INSTANT** access to **HUNDREDS** of other chip collectors.
- ...have a question and need to know the answer **RIGHT NOW!**
- ...want the **BEST** that chip collecting has to offer!

Then you need to log on to

chipguide.com

and

thechipboard.com

With more than 450,000 accesses last year, these two web sites offer constant, nonstop chip collecting action for both the novice and the experienced collector. Come join in the fun!

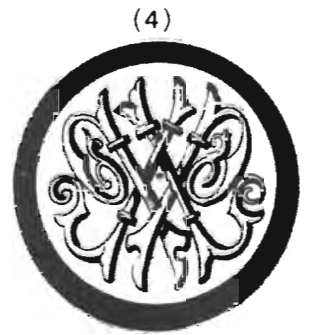
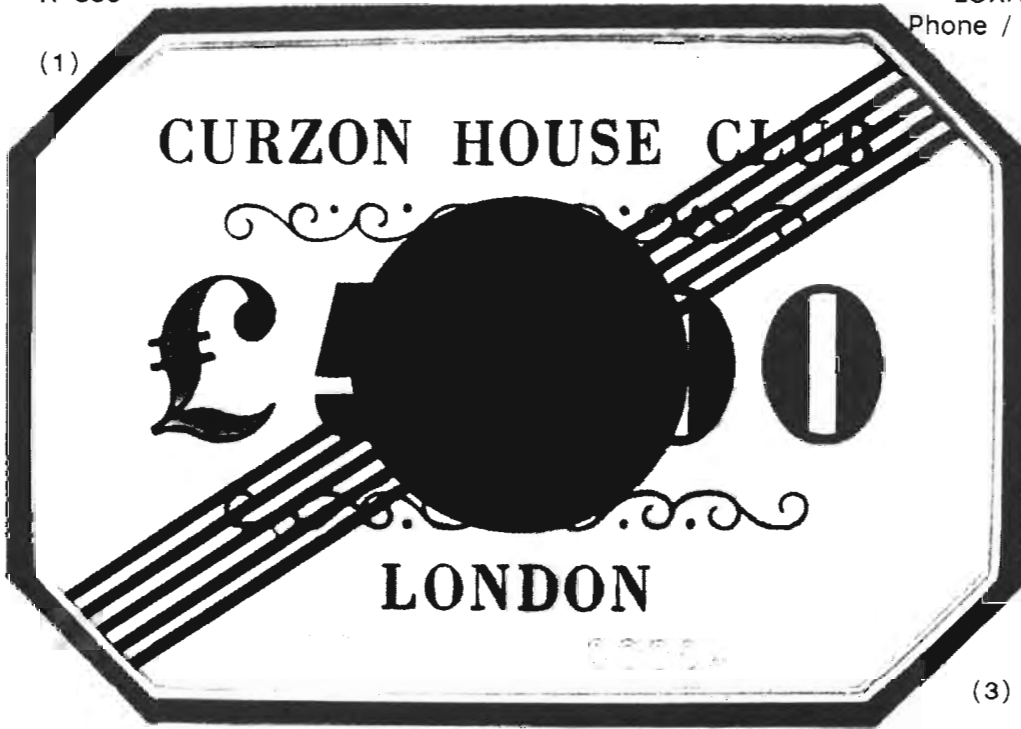

- (1) £5000 - Lemon-Ice with Amber center lunette: \$325.00
- (2) £500 - CURZON HOUSE - Pearly-Blue w/Ruby-Red lunette. 105X77mm: \$375.00
- (3) 250.000F CASINO-KURSAAL OOSTENDE-BELGIUM - Pearly-Blue w/3 pink, amber, and blue lunettes. The Largest denomination of this obsolete series: \$300.00
- (4) JPJP RED scrimshaw monogrammed Ivory gambling chip. RARE: \$400.00
- (5) SHIELD ON STAR Ivory gambling chip w/ Fawn rim: \$400.00
- (6) TIGER - Seymour's code ID-CS: \$400.00
- (7) TIGER - WIDE RIM SHADED-PINK FIELD - RARE: \$700.00

CASINO CHIPS FOR SALE

Current, Face Plus \$1.00, Obsolete start at face plus \$2.00
Send two first class stamps for list and a current chip
Ken Knoff R-805
75 Connoley Circle - Chula Vista, CA. 91911

PREMIUM LAS VEGAS CHIPS WANTED

I'm always looking for premium Las Vegas chips to add to my collection. I'll gladly bid on individual chips or entire collections.
Alex Cilento - R-1243
800-444-6357 alex@aspenventures.com



NEVADA OBSOLETE CHIPS FOR SALE OR TRADE

WRITE FOR LIST
L. C. MEREDITH

P. O. Box 11216N - RENO, NV. 89510-1216

<http://members.ebay.com/aboutme/chips91636@aol.com>



WANTED: \$2.50 chips & Foreign Chips
Send for my list of European, Maryland, Russia, Czech, New Mexico, Etc.

Bob Feeney

Box 2478 - Los Lunas, New Mexico 87031

FREE LIST of \$1.00 CHIPS from THE WORLD

Jerry Hoover (R-2572)

10655 Kinnard Ave., #204

Los Angeles, CA. 90024-5939

(310) 441-1171

jhoover@pepperdine.edu

**Visit our Website at
Cunninghamexonumia.com**

Paul Cunningham (517) 451-2447

**CASINO CHIPS, CARDS, MATCHBOOKS,
POSTCARDS, BOOKS & PAPER ITEMS**

Two first class stamps for Casino Collectibles Catalog and receive a free closed Las Vegas casino postcard with catalog

Donald Spencer, R-0892

14 Twain River Drive Ormond Beach, FL. 32174

SEND FOR FREE LISTS

Nevada & Misc. Chips - - - Silver Strikes

WANTED San Jose Cardroom Chips

Gary Acquistapace

P.O. Box 6091, San Jose, CA. 95150

E-Mail: intochips@aol.com

LOOKING FOR SUPPLIES

Free Illustrated Catalog

C.T. Rodgers - P. O. Box 4572 - Lakewood, CA. 90711

Phone 562-408-2463 - E-Mail ctcoins@aol.com

• Buy • Sell • Trade •

Charles Kaplan

11 Calais Court • Rockville Centre, NY 11570 • (516) 763-2327

<http://pws.prserv.net/ckaplan> • ckaplan@attglobal.net

CC>CC R-2558 • President, NY Metro Chapter

Collector of \$1.00 casino chips from everywhere
*Nevada, Atlantic City, Colorado, Deadwood, Riverboats,
Indian Reservations, Caribbean, Foreign, Cruise Ships*

A Thank You note to the club web site

To all the people that

Helped make the TROP a great convention would go a

loong
way

BUYING DUTCH CARIBBEAN

CHIPS & TOKENS

Send Photocopies, not items to:

RALPH P. POLLACK

P.O. BOX 79216

DARTMOUTH, MA 02747

Visit my WEBSITE: www.dartmouthchip.com

MOVING ?!

Don't forget to let our
Membership Director
know your new address.



James S. Steffner

P. O. Box 368

Wellington, OH. 44090

Deadline for next issue



ads is Sept. 1st. 2000





*** WANTED ***

CASINO CHIPS

Buy Sell Trade

Barry Weintraub

Ph: 818-780-6794

Daytime & Evenings

Cassidy Frames

CALL NOW FOR YOUR FREE CATALOG!

1 (800) 941-4491



Casino Chip Display
Solutions & MORE!

also
Check us out
ON-LINE!

Check us out!

www.cassidyframes.com

(702) 658-5417

B & U Coins

Casino Chips • Gaming Tokens
Casino Memorabilia

BETTYE MOWERY
VINCE MOWERY

P.O. Box 33354
Las Vegas, NV 89133-3354



SCOTT HARTMAN "The Chip Man"

BUY * SELL * TRADE
CASINO CHIPS & COLLECTIBLES

Member ANA & CC>CC R-501
P.O. Box 387, Agoura Hills, CA 91376
TOLL FREE 1 (800) LUCK-707
1 (818) 706-1197 * FAX 1 (818) 706-1986

Internet: <http://www.chipman.com>
E-mail: scott@chipman.com

EDWARD B. HOFFMAN, R-2872, CHSS-103 DO I HAVE A PRICE LIST FOR YOU?

1. FRANKLIN MINT PROOF-LIKE 50¢ AND \$ TOKENS
2. NEVADA CASINO \$1 GAMING TOKENS
3. NEVADA \$1 ROUTE TOKENS
4. NEVADA CASINO CHIPS (CHECKS)
5. NEVADA SILVER STRIKES \$7-10-20-40
6. GAMING TOKENS FROM AROUND THE U.S.A.
7. GAMING CHIPS FROM AROUND THE U.S.A.

SEND \$1.00 FOR PRICE LIST OF YOUR CHOICE
OR SEND \$3.00 FOR LIST AND \$1 CHIP OR TOKEN
MAIL: PO BOX 6039-G, ELKO, NEVADA 89802-6039-39
PHONE: 775-753-2435 FAX: 775-777-2667
EMAIL: HOFFMAN@RABBITBRUSH.COM

NEVADA OBSOLETE CHIPS

Steve Soden

SEND FOR FREE LIST

3515 Deer Lane
S. Lake Tahoe, CA. 96150
(530) 541-4052

BUYING NEVADA CASINO CHIPS

BRUCE LANDAU CH-002
44 WEST GATE RD.
SUFFERN, NY. 10801

Day (516) 694-8700 Eve (914) 357-0837
E-Mail: brucechips@aol.com

Chips for Sale or Trade

Obsolete Nevada Casino Chips
Current Chips from Northern Nevada Casinos
Orders taken for Northern California cardrooms,
Indian casinos and Nevada tokens
Send your trade list! New Issues Service Available

Todd Digley R-0554, NCN-001
6 Sandpointe Court, Sacramento, CA. 95831
(916) 393-6464

NEXT DEADLINE FOR ADS IS SEPT. 1st 2000

Free Advertising

www.gamingchips.com



CC>CC #2835

Gaming memorabilia related businesses or web sites, are invited to join our banner exchange program - it's free! Go to gamingchips.com and click on our free banner ad for details.

Obsolete & Current

Nevada, Riverboat, Indian, Colorado, Deadwood,
California and Cruise Line Chips
Also Tokens from Everwhere

Free 1200 Plus Chip and 500 Token List
Trades Welcome

Paul McDonald

3401 Patterson - Amarillo, TX. 79109
(806) 355-9399

WANTED

OLD NEVADA CASINO & HOTEL ITEMS

**SUCH AS: BROCHURES, MATCHES, CHINA
BLK/W POSTCARDS, ADVERTISING
ITEMS, PHOTOS, DICE, KEY CHAINS, ECT.**

SCOTT FAWCETT CH-049
8739 HUDSON RIVER CIRCLE
FOUNTAIN VALLEY, CA. 92708

(949) 756-8677 Work (714) 968-5000 HOME

Learn the History of Your Mystery Chips

Now you can finally learn the history of that mysterious casino chip and even discover the club's location. In this monumental work, author Dwayne Kling, a former Reno casino owner and operator, provides casino opening and closing dates, the type and number of table games and slot machines licensed, and locations and former locations of gaming establishments that few people today may even remember. Kling also includes stories and anecdotes about 345 casinos that were licensed during the first fifty years of Reno gaming and lists hundreds of people employed by those casinos during the golden age of gambling. Owners and operators are listed along with front line gaming employees and the people who worked behind the scenes in the restaurants, bars, advertising, finances, and entertainment.

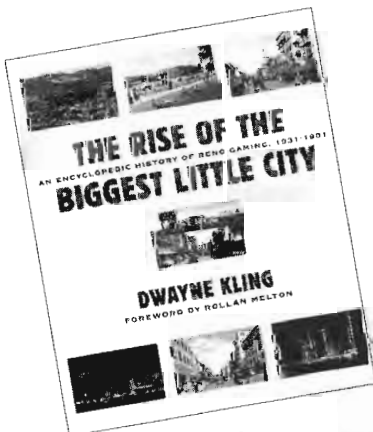

THE RISE OF THE BIGGEST LITTLE CITY

An Encyclopedic History of Reno Gaming, 1931-1981

DWAYNE KLING

hardcover, 256 pages, 76 b/w photos, 6 maps
\$34.95 + \$4.50 UPS delivery

Order today! Call toll free 1-877-NVBOOKS (682-6657)

Mail your order to: University of Nevada Press • Mail Stop 166 • Reno, NV 89557-0076

**BUY & SELL
NEVADA
CUBA
COLORADO**

& many other areas

I Buy Deals

I Sell discount collections

**I build dealer & Collector
groupings**

HENRY GARRETT

P. O. Box 4334

North Hollywood, CA. 91617

Phone (818) 989-0760

E-Mail suprrsting@aol.com

Atlantic City Chips

Complete Collection

From \$1.00 to \$10.00

**From the first chips issued
to New Years eve 2000**

**Send a check for \$2.00 for
a complete seven page list
of condition and prices**

Robert Irving

64 Brook Drive

Holland, PA. 18966

THE DICE MAN

is actively
**BUYING
SELLING
TRADING**

CASINO DICE

From one pair to entire collections

WWW.DICEMAN.NET

Visit the new web site. See the full color sales list
(with pics). learn about casino dice, article archive,
and sign up for FREE newsletter!

BOOKS

Dice Man Speaketh - Las Vegas Edition \$45

Dice Man Speaketh - Reno/Lake Tahoe Edition \$45
Newport, The Real Sin City - \$18

Jeff Landeman (R-3341) PO Box 9293 Canoga Park, CA 91309
diceman@diceman.net



**BUYING
DUTCH
CARIBBEAN**

CHIPS & TOKENS

Send Photocopies,
Not items to:

Ralph P. Pollack

P. O. Box 79213

Dartmouth, MA. 02747

Visit my WEBSITE:

www.dartmouthchip.com

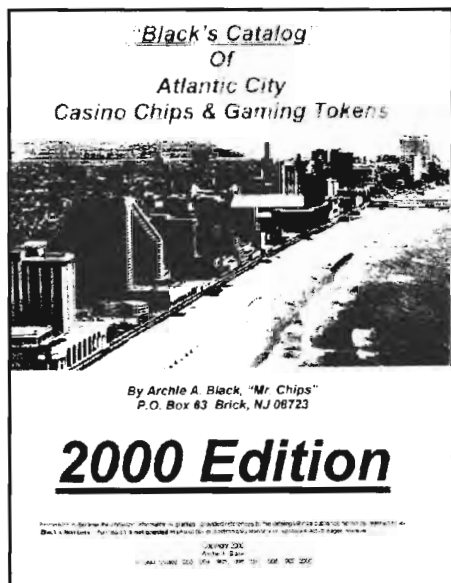

NOW AVAILABLE
"BLACKS CATALOG"
2000 EDITION
OF ATLANTIC CITY
CASINO CHIPS &
GAMING TOKENS

Over 130 pages chock full of information and
 Illustrations on the 2nd largest gaming jurisdiction
 In the world . . . with new 2000 price guide

- ♣ **20+ pages devoted to every current and obsolete A.C. chip illustrated in full color up to the \$100 denominations, including four Atlantic illegals.**
- ♣ **Every known current and obsolete A.C. token listed and illustrated in full size up to the \$100 denominations.**
- ♣ **Every current and obsolete \$10, \$20, \$40 Silver Strike issued in Atlantic City listed and illustrated in full size.**
- ♣ **Fun night chips & paper money, tournament chips, medals, shoe Chips, etc. The complete 8 1/2" x 11" illustrated reference works to Collecting Atlantic City Chips & Tokens**

STILL ONLY \$29.95
PLUS \$3.20 PRIORITY POSTAGE
"BUY THE BOOK BEFORE THE CHIP"

ARCHIE "Mr. Chips" BLACK
P. O. Box 63 - Brick, NJ. 08723

CHIPS OFF THE OLD BLOCK

Terry Lazarus, R-2708...P.O.Box 57...Dallastown, Pa. 17313...1-888-CHIPS-97

E-mail: Pachipper@aol.com

Web site: <http://ocvirtual.com/cotob/>

Selected Specials:

{*Catalog of over 70 pages, 1500+ chips ...\$4 }

Cal-Neva Lodge \$1 Black Rect.	\$185	Indian Springs \$5 – “Millennium Moe”	\$12
Cal-Neva Lodge \$1 Navy S-Mold	\$60	Horseshoe (LV) – WSOP NCV’s 1-5000	\$129
Cal-Neva Lodge \$5 Navy T-Mold	\$175	Villa Sierra \$5 Arodie	\$150
Cal-Neva Lodge \$100 T-Mold HS-Blue	\$250	Bonanza Club 25c Fushcia H-Mold	\$49
Stardust (Tahoe) \$5 Arodie...Near Mint	\$99	Bonanza Club \$5 Navy H-Mold 2-Salmon	\$99
Incline Village \$100 H&C(CJ) Drilled	\$250	Bonanza Club \$25 Cream H-Mold 2-Sal.	\$249
Artichoke’s Poker Palace 1c & 5c... Both	\$55	Fiesta -Royal Flush Series of 24 \$5 Chips	\$230
Crystal Palace 25c Blue None HS	\$80	Share Cropper Club – 50c, \$1, \$5, \$10	\$35
Horseshoe (LV) 6 Colors 8-Suit NCV’s	\$28	Harold’s Club – 2 Diff \$5 Portrait Chips	\$22
Opera House Unicorn Set – \$5, \$25, \$100	\$55	Horseshoe Club (Reno) – 3 LgKey R’lette	\$28
King’s Castle \$1 Free Play – Gray, Mint	\$40	Casino de Capri – Set of 3: \$1, \$5, \$25	\$39
King’s Castle \$5 Free Play – Pink, Mint	\$45	Dunes FARO Orange Unused	\$32
Palace Club (Fallon) \$1 Purple Sm Key	\$25	Bally’s Grand (AC) Hall of Fame Set of 5	\$65
Stork Club (LV) \$5 Circa 1940’s	\$350	Lady Luck 3 Diff \$.25 Diecar, H&C, Nev	\$50
Stork Cluv (LV) \$25 Circa 1940’s	\$375	Club Forest (La. Illegal) \$1 Lime LgSq	\$12
Stork Club (LV) \$100 Circa 1040’s	\$395	Orig. Club Forest \$1 Green Star Mold	\$12
Jailhouse \$5 Red Diecar 3-Navy HS Gold	\$12	Pink Pussycat (Reno) 1,2,5 – All 3 No “S”	\$65
Jailhouse \$25 Dk. Green Diecar 3-Pink	\$25	Hard Rock \$5 – ZZ Top	\$25
Joe’s Tavern \$1 Navy TK None HS Gold	\$65	Laughlin – River Run 2000 – 8 Diff. \$5	\$88
Silver Smith \$5 Yr of Dragon 250 Made!	\$25	Curzon House (London) 10 Pd Plaque	\$45
Railroad Pass \$.10 Navy Ewing None HS	\$22	Curzon House (London) 50 Pd Plaque	\$75
Ponderosa \$1 Navy LgKey 3-Pink	\$38	Curzon House (London) 100 Pd Plaque	\$90
Poor Pete’s (Reno) \$5 – Navy SmKey	\$24	49er \$5 Fushcia H-mold None	\$50
Harrar’s (Lghln) \$2.50’s DH #1, #2, \$3	\$22	Mapes \$5 - Brown T-Mold 4-Rust	\$14
Sahara (LV) \$20 Baccarat Plaque (60’s)	\$45	Mapes \$25 – Green T-Mold 4-White	\$14
Norwegian Cruise Lines \$5 Millennium	\$12	Sahara \$2 Navy H&C 2-Orange HS Gold	\$18
Caesar’s Tahoe NCV Green 4-Tan HS	\$18	Scrubby’s (Montana Illegal) TK Set of 2	\$30
Harrar’s Reno:Set 13–Gaming thru Ages	\$105	Cedar Crest CC (Waco, TX.) – Black	\$25
Reno Hilton: Set 12–Countdown to Mill.	\$99	Sands 3 Chip Tourney Set \$5, \$25, \$100	\$95
Hyatt Regency – Set of 5- Full Graphics	\$45	Overland Hotel 10c Fushcia SmCrown	\$14
Harvey’s \$25 Orange Brass	\$99	Holiday International - \$1, \$5, \$25	\$29
Harrar’s Collector Series '90 Sailboat	\$18	Sundowner/Virginian \$1 HHR – Error	\$75
Carson Nugget – Millennium Set of 5	\$45	Caesar’s (AC) – Cher \$25 – Year 2000	\$69
Cal-Neva/Virginian – Mill. Set of 4	\$38	D.T. Saloon \$1- First Issue 8-Suits White	\$19
Chuck’s Golden Spike 25c	\$19	D.T.Saloon \$5 -First Issue 8-Suits Red	\$38
Chuck’s Golden Spike \$1 & \$5 Non-Neg	\$39	The Cove \$1 (Cal Illegal) Great Hotstamp	\$30
BPOE #99 (Los Angeles) \$5 Crest & Seal	\$12	Canterbury Card Room (Minn) - \$10 GO	\$20
Red Lion (Elko) – 2000 Cowboy Poetry	\$12	Stever’s Social Club-Set 3 – Mo. Illegal	\$25
Nevada Club (Eureka) \$1 White Diecar	\$28	Foxwoods \$10 – Frank Sinatra	\$38
Bonanza (French’s) \$5 Brown 4-Beige	\$50	Jim Kelly’s Nugget \$1 Lg Key Maroon	\$35
John’s Tahoe Nugget \$500 Brown Ewing	\$28	Jim Kelley’s Nugget \$1 Lg Key Gray	\$30
Owl Club (Eureka) \$5 Red H&C	\$18	Meeks Bay (Tahoe) \$1, 2.50, 5, 25, 100	\$49
SaharaTahoe \$1Yel Horshu TableGames	\$14	Oliver’s (Tahoe) 25c H&C(CJ)	\$45
SaharaTahoe \$5 Horshu TableGames	\$22	Peppermill (Reno) \$5 GO – NCV	\$49
Joe’s (Gerlach) \$1 Orange SqinCir	\$115	Monte Carlo (Reno) \$1, 2.50, 5, 25 O/S	\$39
Tahoe Nugget \$1 Red H&C(CJ) New!	\$75	Reno Hilton \$5 Rainbow 3-Gray 3-Pink	\$35
Tahoe Nugget \$5 Yel/Brn Pie H&C(CJ)	\$70	Diamond Club (New York City) \$1 & \$5	\$28
Sahara Tahoe \$100 Orange Lg Key NN	\$55	The Nugget (Reno) Grn H&C(CJ) 3-Red	\$49
Boomtown (LV) Tourney Set-\$1,5,25,100	\$25	Sparks Ngt \$.25 Orange Outline of Ngt	\$95





Please add \$3 S&H on all orders. Money orders & PayPal sent immediately.



Est. 1995

GRAND OPENING

We are pleased to announce the **GRAND OPENING** of our **NEW Shopping Cart Enabled Web Site**. All of our products can now be purchased online at www.tinytreasures.com

-  **New online virtual shopping cart.**
-  **All transactions fully encrypted.**
-  **Fast, easy, and fun to use.**
-  **All major credit cards accepted.**
-  **Also works for fax and mail orders.**

Check out these

HOT

Internet **SPECIALS:**

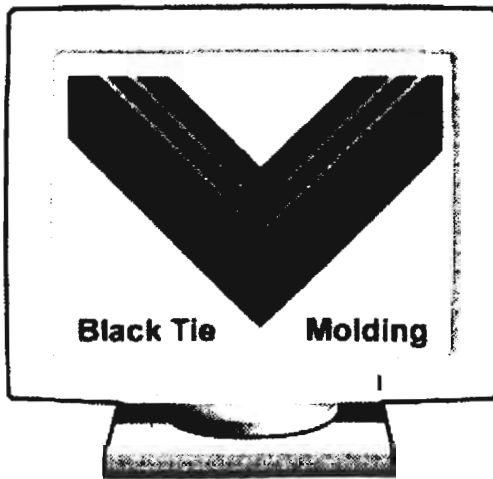

- 12 Chip Frame with Black Tie Molding, Only \$19.90
- 20 Chip Frame with Black Tie Molding, Only \$24.90
- 35 Chip Frame with Black Tie Molding, Only \$29.90
- 63 Chip Frame with Black Tie Molding, Only \$39.90
- Air Tight Holders for Regular Casino Chips \$0.50
- Replacement Capsules for \$10 Silver Strikes \$0.50
- Air Tight Holders for \$10 Silver Strikes \$0.65

.....
Visit our web site today or call for a free catalog.

www.tinytreasures.com



Tiny Treasures
2 Klarides Village #269
Seymour, CT 06483



Christopher Colangelo R-1658
Phone: 800.747.8469
Fax: 800.419.3603
E-Mail: chris@tinytreasures.com



**Soft plastic
storage pages will
damage your chip
collection!
Try our new
Jewel Frames!!**



**Offering two product lines for all
your display and storage needs:**

The most unique displays available today and a safe, secure, and convenient modular system for long term storage of your casino collectibles

DISPLAYS

- See BOTH SIDES of your collection!
- Hang display on the wall
- Choose from NINE colors of panels
- Frames handcrafted from quality oak
- You choose size of frame
- Display from 1 to 400 chips/tokens
- Acrylic protects chips from light rays
- Kit allows for easy transportation
- Kit allows for low-cost shipping

DON'T JUST COLLECT IT, SHOW IT OFF!

STORAGE

- Totally modular!
- See BOTH SIDES of your collection without handling chips/tokens!
- Enclosed case provides protection!
- Each unit holds between 1 and 8 chips
- Mix standard chips, oversize chips, LE's, sets, and special chips together!
- Easily fits into almost any storage unit designed to hold CD's!
- Easily transported!
- Monthly subscription service available



Tyrus R. Mulkey
CC>CC# LM 2211-21
Proud to be a Lifetime Member!
Southern NV Chapter #R-137
Tyrus@TyrusRex.com

TyrusRex, Inc.
2657 Windmill Pkwy #408
Henderson, NV 89014
Phone/Fax (702) 896-5065
Toll Free (800) 317-1614

We have an online catalog with secure ordering at

www.TyrusRex.com

WE are gonna have fun at

CASINORAMA

America's PREMIER casino collectibles show is coming to Arcadia on

Saturday, October 21st, 2000

Show Hours are 9:00 am untill 4:00 pm, \$5 admission (Kids Free)

\$ BUY - SELL - TRADE \$

**CHIPS - TOKENS - DICE - SILVER STRIKES
ASHTRAYS - POST CARDS - Everything CASINO**

**Bid Board, Great food, Free Parking, Friendly Folks
Plenty of idle chatter, enjoy the day**

ARCADIA MASONIC HALL

50 West Duarte Road, Arcadia, CA.

Foothill Freeway (210) South on Santa Anita to Duarte Road, or North on Santa Anita from San Bernardino Freeway (10) Easy to find, bring your traders

**Don't miss the exciting CRYSTAL PARK Hotel and Casino Show
Friday, Aug. 11th and Saturday, Aug. 12th 2000**

CONTACT: Jim Munding (626) 919-0603

P. O. Box 4087, West Covina, CA. 91791 for information

E-Mail: MUN3335@aol.com

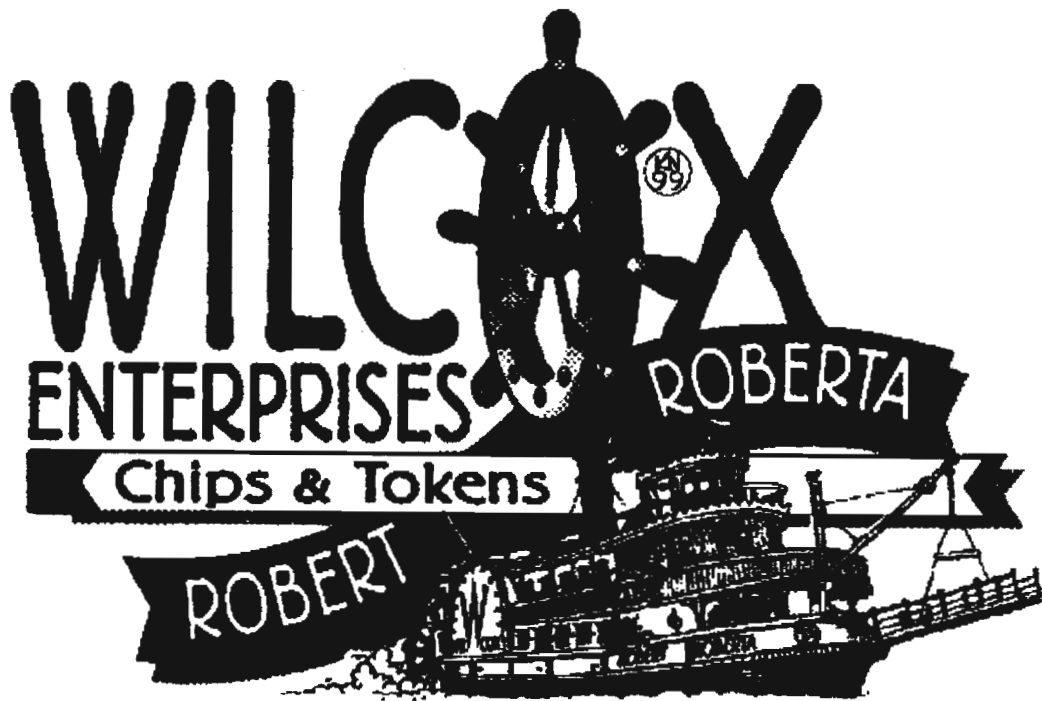

NEW ISSUE SERVICE

RIVERBOATS

COLORADO

INDIANS

DEADWOOD

We specialize in keeping your collection up-to-date. If you collect Riverboats, Indians, Colorado or Deadwood, let us track down the chips and tokens and send them to you in our monthly shipments. With a 10% discount off our regular retail price, \$1 items cost 2.70 and \$5 items cost 7.65. You can specify what items you want us to send you and still return any items you do not want.

See our monthly ad in the "Gaming Times" for a list of new items available each month. We also maintain a Web site at <http://www.adams.net/~rwc/wilcox> where you will find a copy of our catalog, recent ads announcing new items and trip notes. We receive e-mail at rwc@acm.org and regular mail at:

WILCOX ENTERPRISES
P O BOX 395
CARTHAGE, IL 62321

You can reach us by telephone at 217-357-3308. Sunday afternoon and evening is when we process orders and is the best time to call, unless we are off chasing chips, in which case everything stops until we get back.

We have an extensive collection of both current and obsolete items from the areas we service. Orders are generally processed over the weekend and shipped on Tuesday, but large complex orders may take longer. If we can be of assistance to you, we would like to make your acquaintance. Please either phone, write or e-mail.

Robert Wilcox Cook

CC>CC # R-0577

Roberta Cook

Hygrade Binders



**Holds 200
Chips!**

www.casinochipbinder.com

Containing 10 pages, each 8" x 9" sturdy page holds 20 chips snugly. Unlike standard 3-ring notebooks and vinyl pocketed pages, chips won't fall out even when vigorously shaken upside down! No flips are needed which further adds to the value of this economical binder.

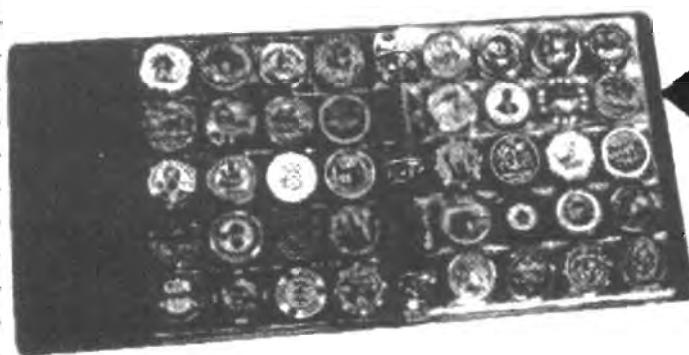

The binder's D-ring design lies flat for easy viewing!

**Only \$19.95
Each****

** Please add \$2.00 shipping per binder. Order two or more binders and shipping is FREE!

Cheques in the Mail, Inc.
232 N. Jones Blvd., #117
Las Vegas, NV 89107-1478
Phone: (702) 877-0460 • Fax: (800) 466-5317
e-mail: chips@intermind.net
web: www.lasvegas-chips.com
Dave & Debbie Harber #R-2283



Also Available from these Fine Dealers:

C.T. Coins • (562) 408-2463
Cassidy Frames • (800) 829-3415
Tiny Treasures • (800) 747-8469

Dealer Inquiries Welcomed, call (702) 877-0460 for more information!

HELLO FROM PUERTO RICO

SUPER SPECIAL

P. R. COLLECTORS & DEALERS

- 3 Different Current \$1.00 Chips \$5.00**
- 3 Different OBSOLETE \$1.00 Chips. \$5.00**
- 3 Different OBSOLETE \$500.00 Chips \$5.00 ea.**
- 5 Different Las Vegas Current \$1.00 Chips \$5.00**
- 5 Different Atlantic City Current \$1.00 Chips \$5.00**
- 3 Different River Boat Chips Current \$1.00 Chips . . . \$5.00**
- 3 Obsolete Cruise Ship Chips \$5.00 \$25.00 & \$100.00 \$5.00**

CUBA - CUBA - CUBA

1 GENUINE CUBAN CHIP *priced at only* \$5.00

100 Different P. R. Obsolete Casino Chips \$1250.00
Color Photo \$25.00 Refunded with order

500 Different P. R. Obsolete Casino Chips \$55,000.00

1000 Different P. R. Obsolete Casino Chips \$500,000.00
"O.K!" I will take \$255,000.00

Orders under \$55.00, Please add \$5.00 S&H HELP
Please send for my current list., only \$5.00, Stamps OK
Refunded with first order
CC>CC # R-0278

ALBERT H. ROLLINS

P. O. Box 190449

San Juan, P. R. 00919-0449

N E W E D I T I O N

CASINOS of
ARUBA, BONAIRE, CURACAO, ST. MAARTEN
& INTRODUCING SURINAME
THE DUTCH CARIBBEAN

By Ralph P. Pollack

NOW FEATURING RARITY AND RELATIVE VALUES
ON ALL
CHIPS, TOKENS, JETONS & PLAQUES

~ Over 1000 CHIPS & TOKENS ILLUSTRATED ~

ONLY \$36.95

PLEASE SEND CHECK OR MONEY ORDER TO:

D.C.E.

C/O RALPH P. POLLACK

P.O. BOX 79216

DARTMOUTH, MA 02747

Please add \$3.20 for priority mail.
MA residents, please add 5% MA tax.

come visit us at www.dartmouthchip.com



LONG BEACH COIN & COLLECTIBLE EXPO



Held at the Long Beach Convention & Entertainment Center, 100 Pine, Long Beach, California
Show Site Phone (562) 436-3636

Only \$4 entry - good for all four days of show! Coin & Stamp club members get in free with proof of membership

Upcoming Show Dates:

◆ **October 5-8, 2000** ◆ **February 22-25, 2001** ◆ **May 31 - June 3 2001**

**Over 400 booths of U.S. & World Coins, Paper Money, Stamps, Post Cards.
Sports Cards, Phone Cards, Collectibles Dealers and more...**

**Over 2000 Dealers buying and selling
Over 60 Ancient & Foreign Coin Booths**

AUCTIONS BY:

Heritage Numismatic Auctions & Ponterio & Associates

Outstanding Forums, Seminars and Special Exhibits every show

- | | |
|-------------------------------------|--|
| * PCGS Educational Forum | * LOBEX-Stamp Section |
| * All Grading Services | * Women in Numismatics |
| * Early American Coppers | * Society for U.S. Commemorative Coins |
| * Civil War Token Society | * Cigar Label Society |
| * National Silver Dollar Roundtable | * Young Numismatists Activities |
| * Colonial Coin Collectors Club | * American Society of Check Collectors |
| * ANA Authentication Bureau | * Society of Lincoln Cent Collectors |

**Booth Space Availability is very limited
For Information**

Phone (805) 962-9939, Fax (805) 963-0827, E-Mail: lbexp@gte.net

1103 State Street, Santa Barbara, California 93101

Visit our web-site at: <http://longbeachshow.com>



Official Expo Sponsors



**Expo Co-Sponsor
LONG BEACH
COIN CLUB**

The Austrian Mint

**LOBEX*
Official Sponsor
LONG BEACH
STAMP CLUB**

Held in conjunction with the
Long Beach Coin & Collectible Expo

CASINOS of
ARUBA ~ BONAIRE
~ CURACAO ~
ST. MAARTEN ~ SURINAME

The Dutch Caribbean



By Ralph P. Pollack

GAMING PLAQUES & JETONS



Quality & Technology



Finished Plaques & Jetons

Shown below are plaques and jetons with various finishes and features.

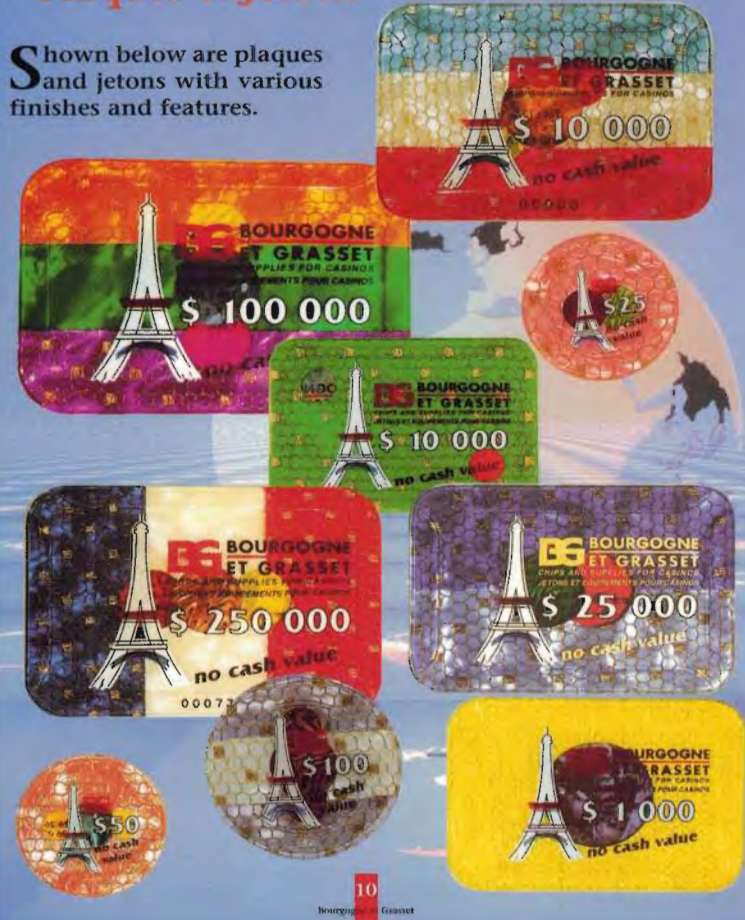

Gaming Plaques & Jetons

Bourgoigne et Grasset continue to lead the world in the manufacture of gaming plaques & jetons. Throughout the world more and more casinos are buying our products. This growth is due to our unique products which offer aesthetic appeal, security, reliability and a long life span.

Our unique system allows you to create your own personalized plaque or jeton for your casino. To assist you in making your selection this brochure is laid out in a simple form progressing from our standard jetons and plaques to our more complex products which incorporate our unique security features.

First you should define the number of plaques or jetons you require, the size and colour and which different options you will need. Such as the number of background colours (2 or 3) and special markings, the print colours, the number and size of any lunettes you wish to incorporate and whether your wish to have a numbering system.

SHAPES AND SIZES

Our plaques are available in 3 different shapes, each available in different sizes.

Our rectangular plaques are available in the following sizes: 58 x 38 mm, 68 x 48 mm, 82 x 57 mm, 95 x 66 mm, 102 x 70 mm, 108 x 75 mm, 119 x 82 mm, 129 x 90 mm, 140 x 97 mm and 151 x 105 mm.

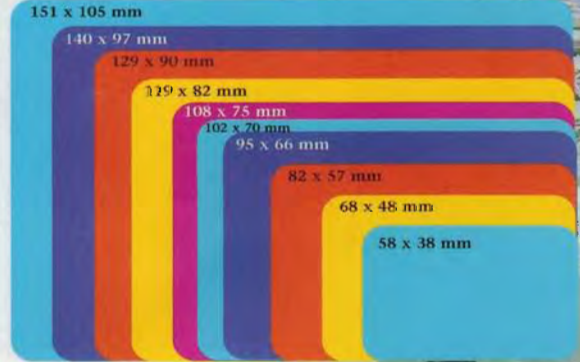

Shapes & Sizes

Rectangular plaques are normally manufactured with round corners but are also available with cut corners as shown opposite.



Our oval plaques are available in the following sizes: 58 x 38 mm, 68 x 48 mm, 82 x 57 mm, 95 x 66 mm, 108 x 75 mm and 119 x 82 mm, 129 x 90 mm, 140 x 97 mm and 151 x 105 mm.

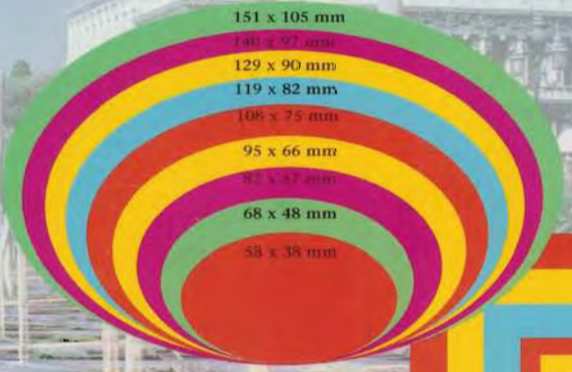

Our square plaques are available in the sizes: 48 x 48 mm, 55 x 55 mm, 60 x 60 mm, 70 x 70 mm, 80 x 80 mm, 90 x 90 mm.



Our jetons are available in the following diameters: 32 mm, 34 mm, 36 mm, 38 mm, 40 mm, 43 mm, 45 mm, 48 mm, 51 mm, 53 mm, 55 mm and 60 mm.

